

048933 | Legrand FT



**Détecteur de mouvement autonome
ECO 2 - 3 fils - Fixation en saillie - IP
55 - Tête orientable**

Réf 048933

186.95€^{TTC*}

Voir le produit : <https://www.domomat.com/43178-detecteur-de-mouvement-autonome-eco-2-3-fils-fixation-en-saillie-ip-55-tete-orientable-legrand-048933.html>

*Le produit Détecteur de mouvement autonome ECO 2 - 3 fils - Fixation en saillie - IP 55
- Tête orientable
est en vente chez Domomat !*

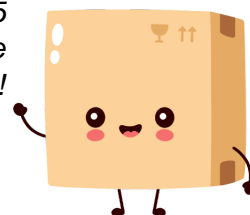

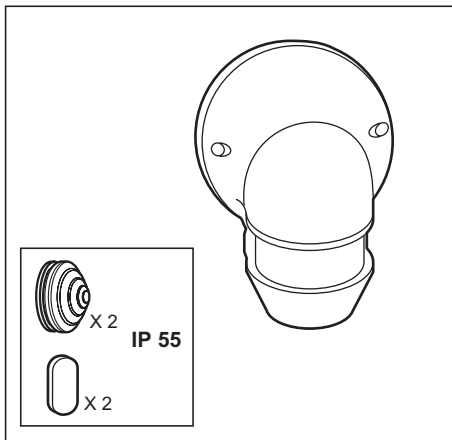

	100 V~ - 240 V~
	50 / 60 Hz
	8 mm 2 x 2,5 mm ²
	-5°C / +45°C
	PIR
	150 lux
	15 min.
	Ø 5 m
	15 m

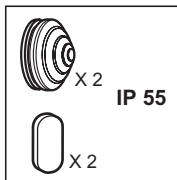

230 V~	2000 W	8,5 A	1000 VA	4,3 A	1000 VA	4,3 A	10x(2x36 W)	4,3 A
110 V~	1000 W		500 VA		500 VA		5x(2x36 W)	

230 V~	250 W	1 A	250 W	1 A	250 W	1 A	500 VA	2,1 A
110 V~	125 W		125 W		125 W		250 VA	

230 V~	500 VA	2,1 A max.
110 V~	250 VA	
U ≤ 30 V=	2,1 A max.	I max. ≤ 2,1A

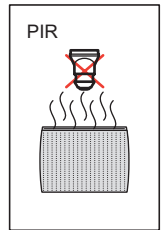
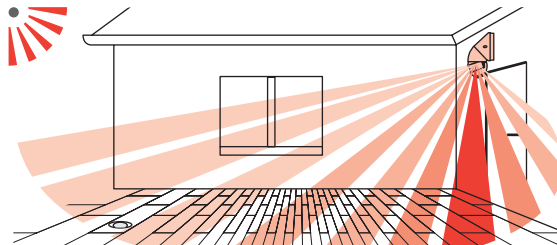
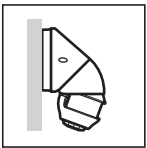
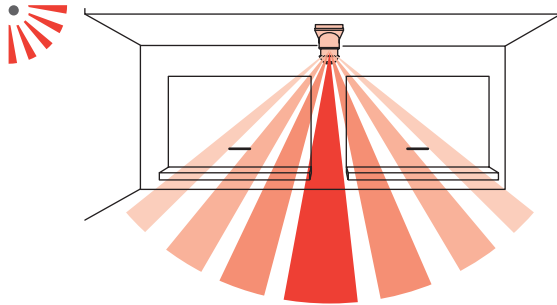
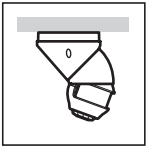
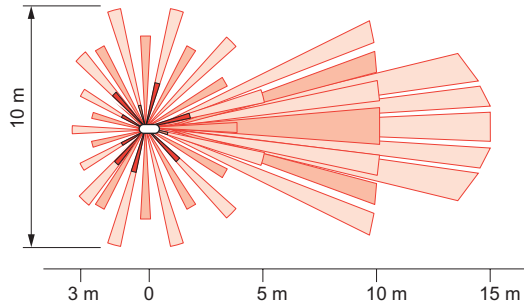
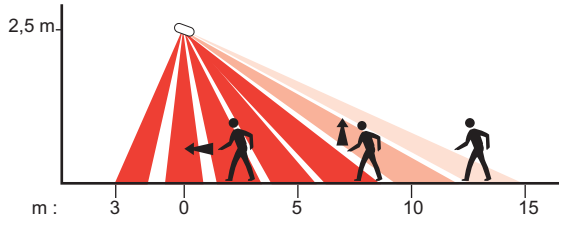
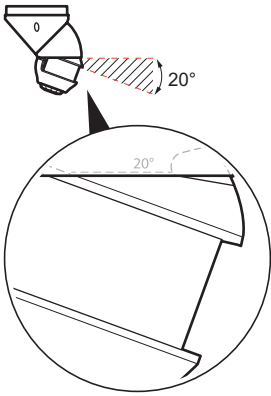

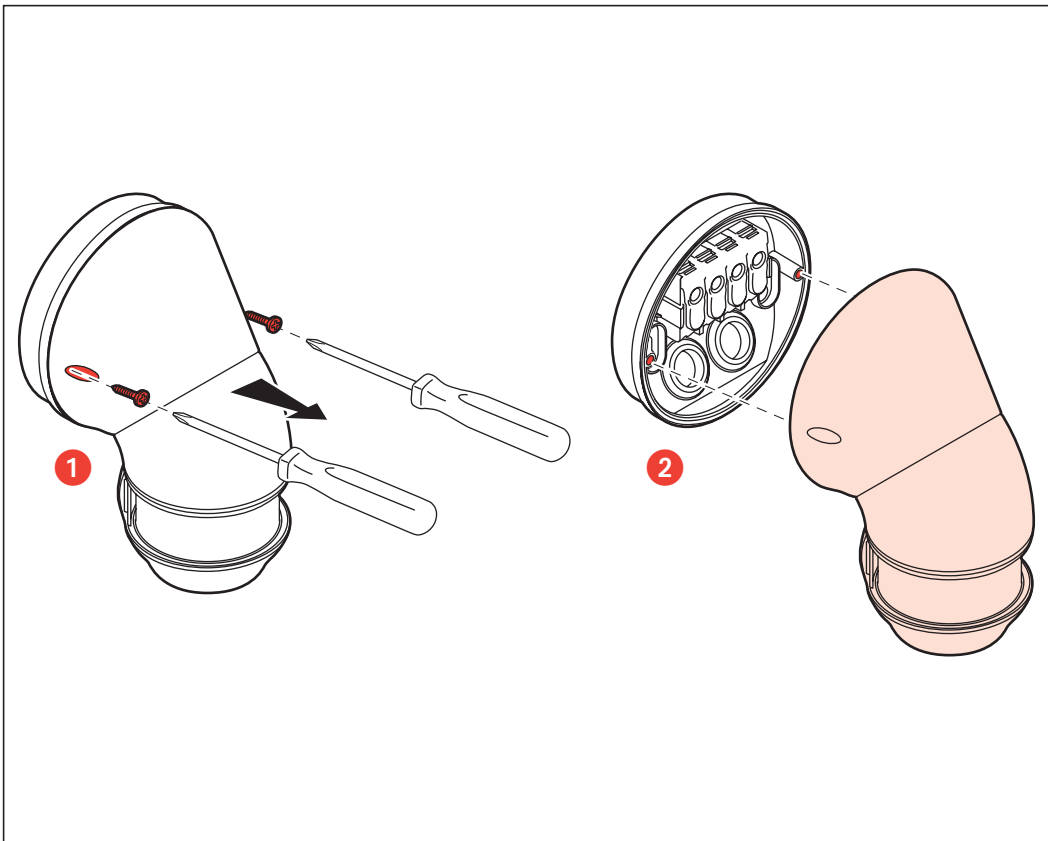
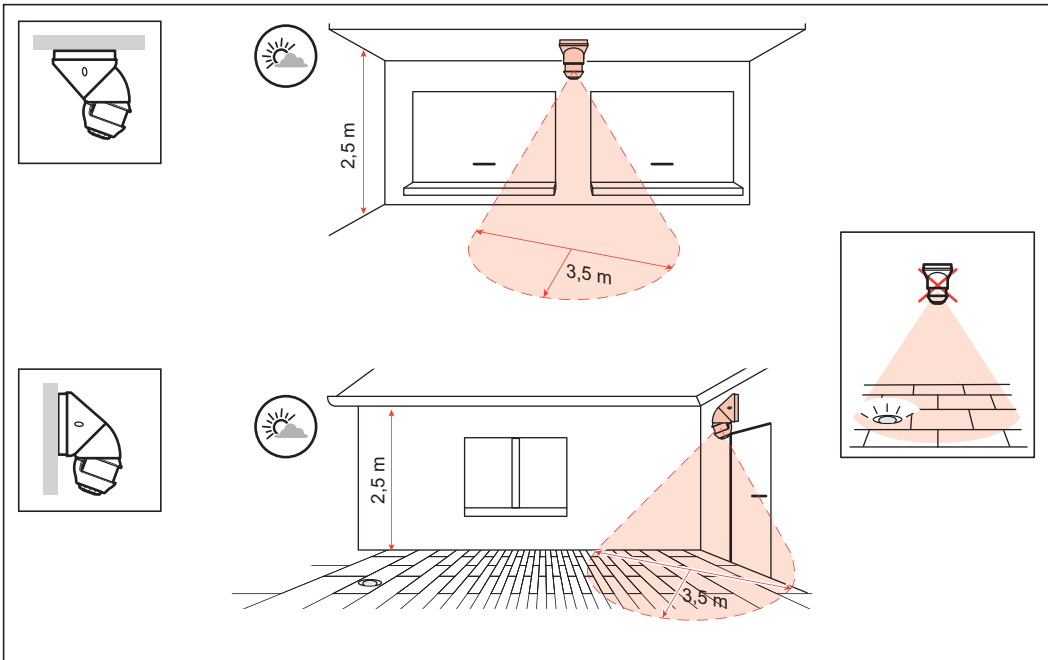

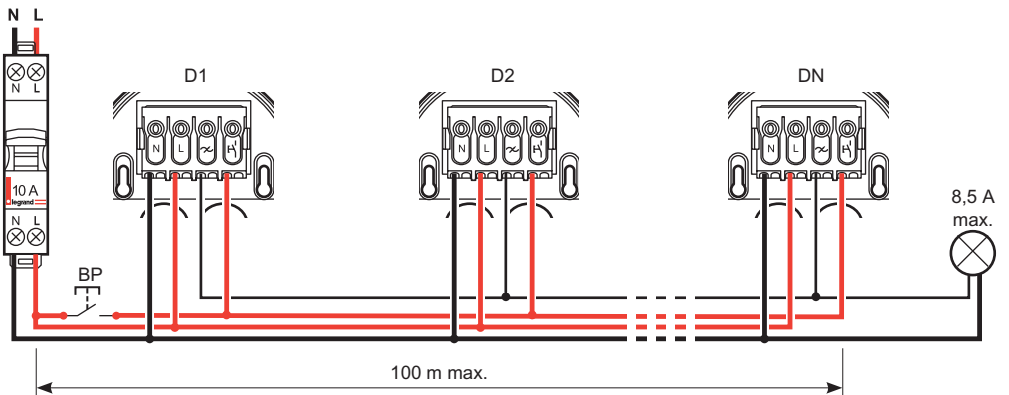
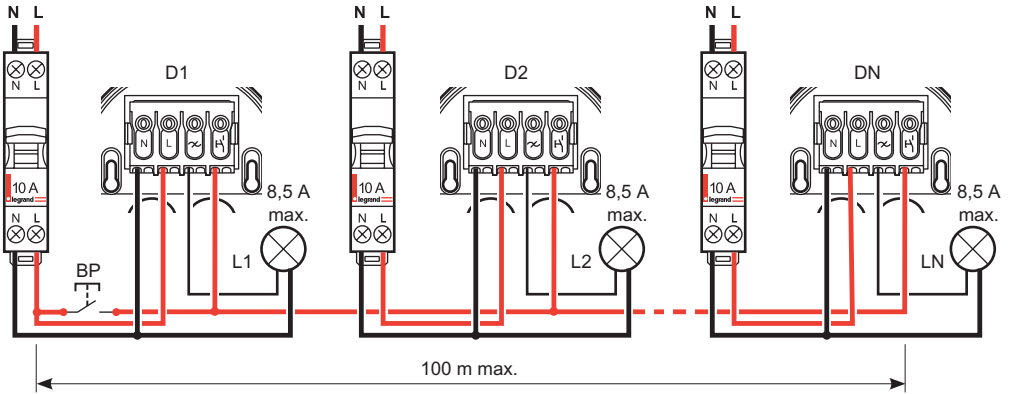
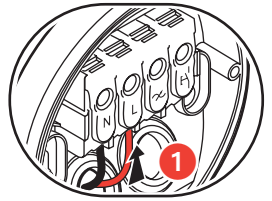
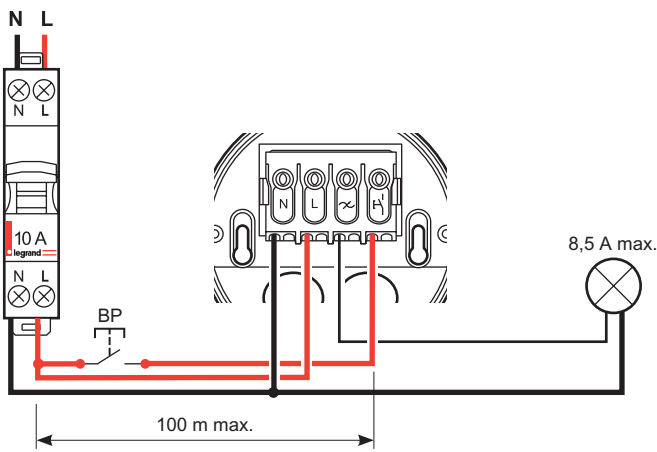

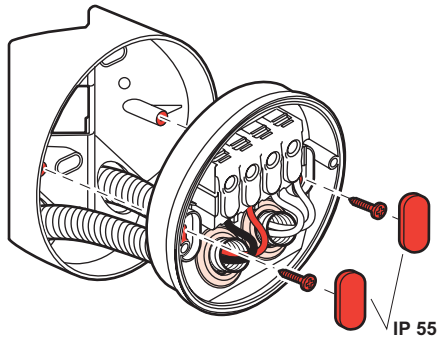
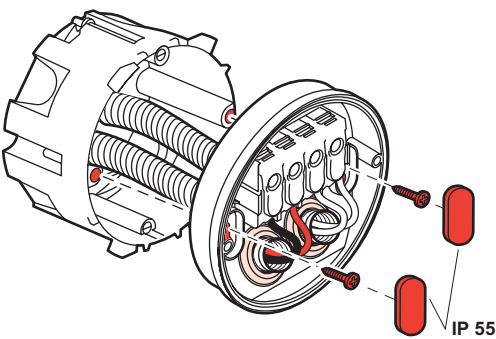
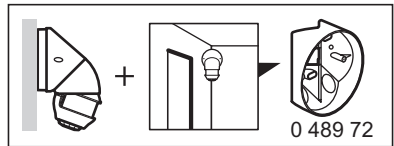
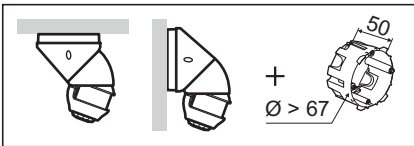
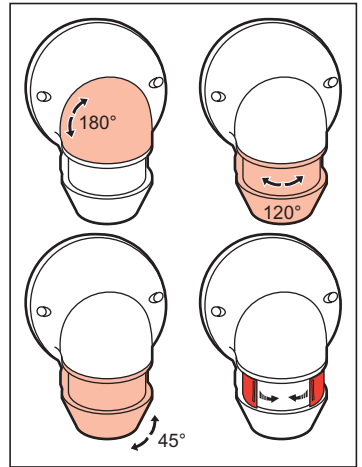
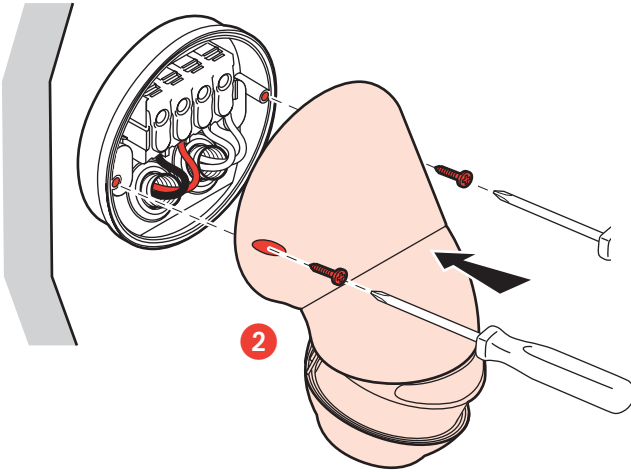
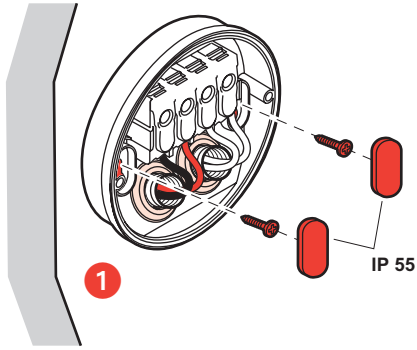
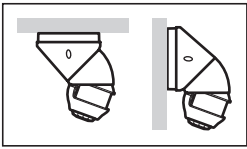



Auto ON/OFF

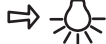
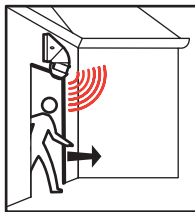

Manual ON / Auto OFF

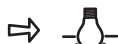

www.legrandoc.com

	5 - 1275 lux
	5 sec - 59 min 59 sec
	25% - 50% - 75% - 100%
Mode	Auto - Manual - Walkthrough



0 882 30



0 882 35

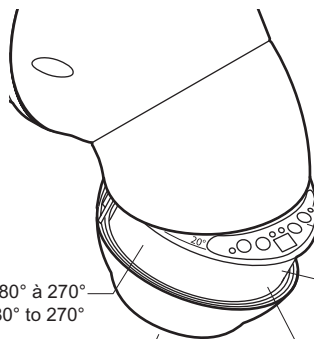

• LED Learn
• Learn LED

• Bouton Learn
• Learn Button

• LED de détection
• Motion LED

• Détecteur/
capteur PIR 180° à 270°
• PIR sensor 180° to 270°

• Détecteur/capteur PIR 360°
• PIR sensor 360°

• Cellule de luminosité
• Daylight sensor