

048952 | Legrand Notice



**Détecteur PIR - Très basse tension -
ON/OFF - 3 fils - IP 40 - Ecodétecteur
- Encastré**

Réf 048952







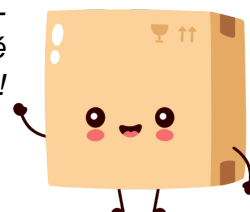



139.04€^{TTC*}

Voir le produit : <https://www.domomat.com/43337-detecteur-pir-tres-basse-tension-onoff-3-fils-ip-40-ecodetecteur-encastre-legrand-048952.html>

*Le produit Détecteur PIR - Très basse tension - ON/OFF - 3 fils - IP 40 - Ecodétecteur -
Encastré
est en vente chez Domomat !*



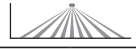

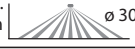
		10-26.5 V \sim / 50 Hz	11.5-36 V \equiv
	1.5mm ²		
	- 10 °C / + 30 °C		
	 PIR		
	1000 lux		
	20 min.		
	Auto ON / OFF		
	min. 3 m	 \varnothing 8 m	max. 15 m  \varnothing 30 m

- Alimentation très basse tension (min 11,5 VDC max 36 VDC / min 10 VAC max 26,5 VAC) avec sortie relais 6 A pour charge résistive / 2 A pour charge inductive
- Low voltage supply (min 11.5VDC max 36VDC / min 10VAC max 26.5VAC) with relay output rating 6 A resistive load / 2 A inductive load
- Alimentazione a bassissima tensione (min 11,5 VDC max 36 VDC / min 10 VAC max 26,5 VAC) con uscita a relé 6 A per carico resistivo / 2 A per carico induttivo

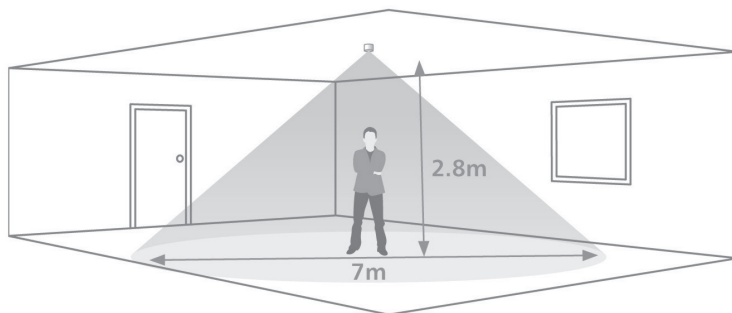

Area of high sensitivity

Area of lower sensitivity

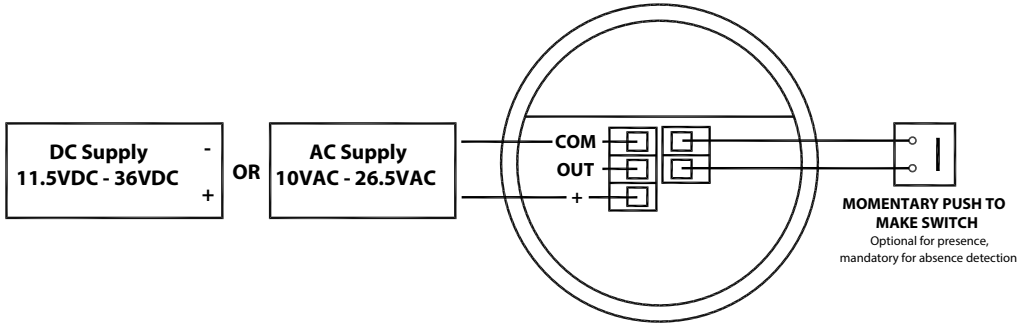
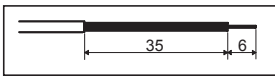
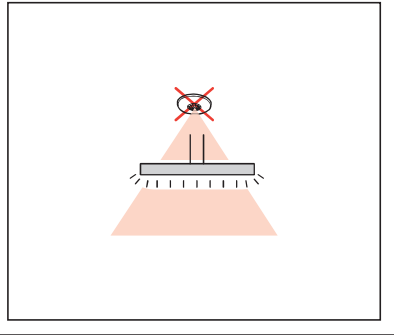
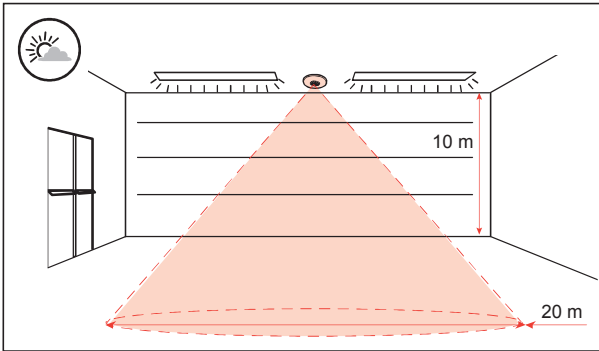
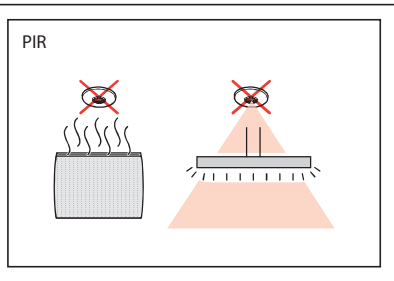
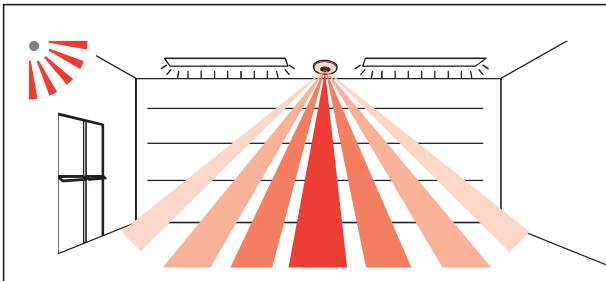

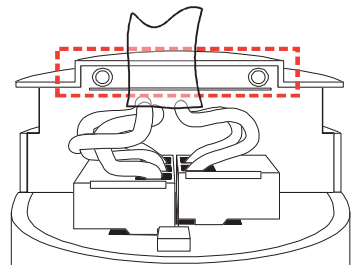
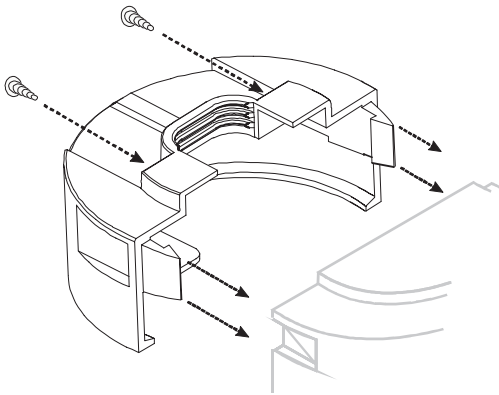
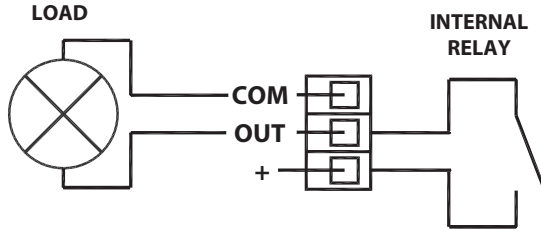
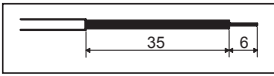

- **Fixation encastrée**
- **Flush Fixing**
- **Montaggio a filo**

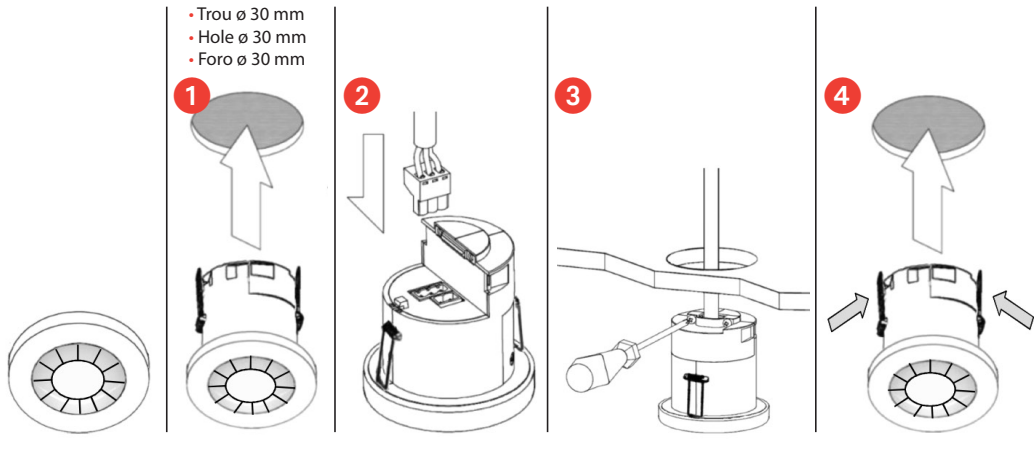

- **Fixation en saillie**
- **Surface Fixing**
- **Montaggio in superficie**

- Faire attention à la compression des ressorts lors du montage de l'unité
- Warning - be careful bending springs when mounting unit
- Piegare le molle con cautela durante il montaggio dell'unità

- 1**
- 50 mm or 60 mm entraxes de fixation
 - 50 mm or 60 mm fixing centres
 - 50 mm o 60 mm di distanza di fissaggio
- 2**
- Tirer sur le clip de fixation et le faire pivoter comme indiqué
 - Pull out spring tab and rotate spring arm as shown
 - Tirare la clip e ruotare come mostrato

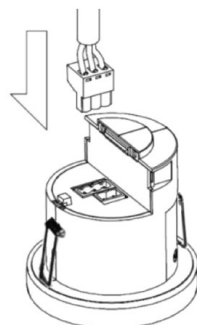
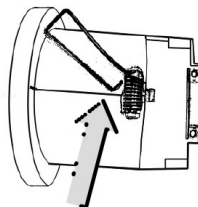
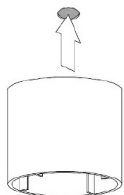
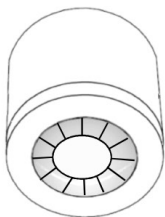

4

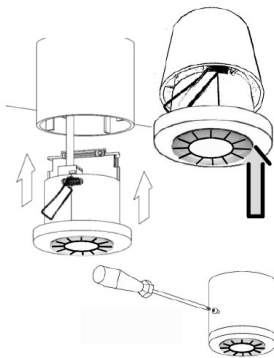



Auto ON / OFF



Manual ON / Auto OFF

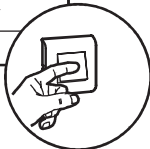

www.legrandoc.com

	0-1000 lux
	0-99 min.
	1-9
Mode	Auto - Manual

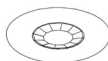
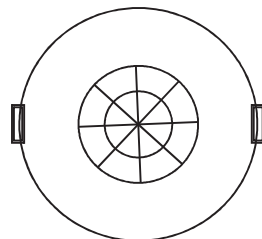

- Contacter votre agent commercial pour obtenir l'outil mobile de configuration
- Please, contact your sales representative to get the infrared handset for programming
- Per favore, contattate il vostro responsabile commerciale per ricevere il telecomando di programmazione