

important

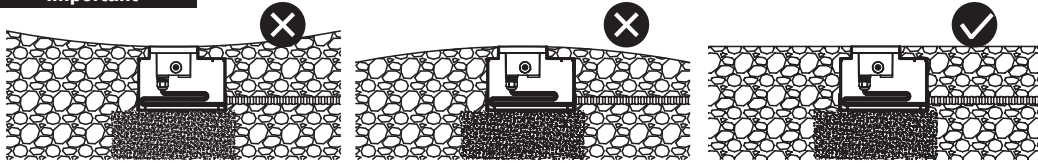

concrete installation

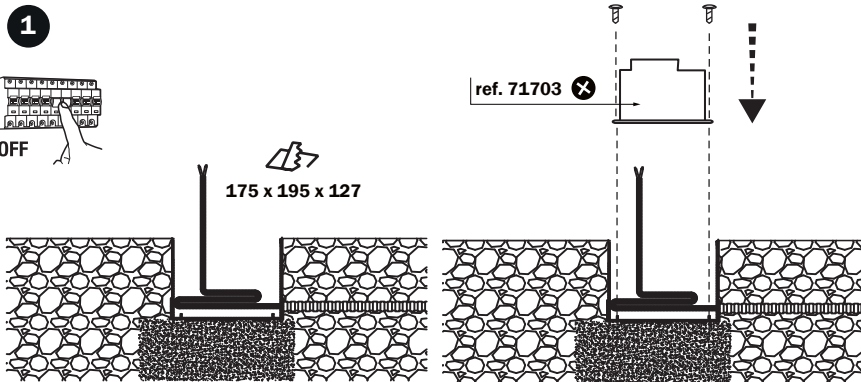

ground installation

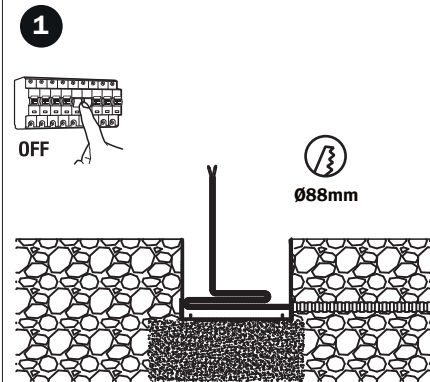

i note: max 3 TRAS for each driver.

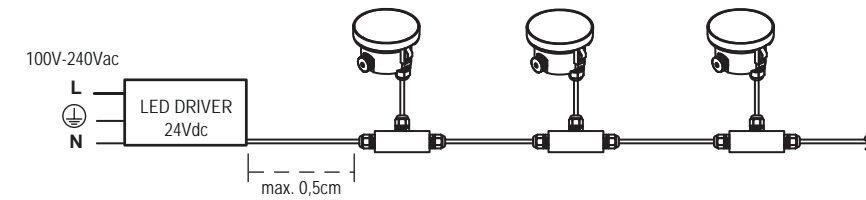

i note: MIN IP65 WIRING CONNECTION BOX - NOT INCLUDED

The block of connection is not included. The installation can need the intervention of a qualified person. The block of connection must comply EN 60998-2-1 or EN 60998-2-2.
The block of connection: MAX 10A
El bloque de conexión no se incluye. La instalación puede requerir la intervención de una persona cualificada.
El bloque de conexión a incluir debe ser conforme con la EN 60998-2-1 o EN 60998-2-2
Bloque de conexión: MAX 10A,

Example - Ejemplo

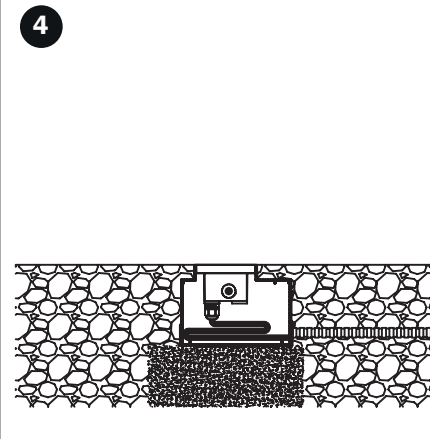
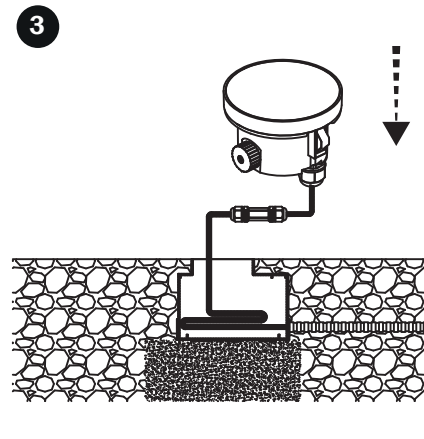
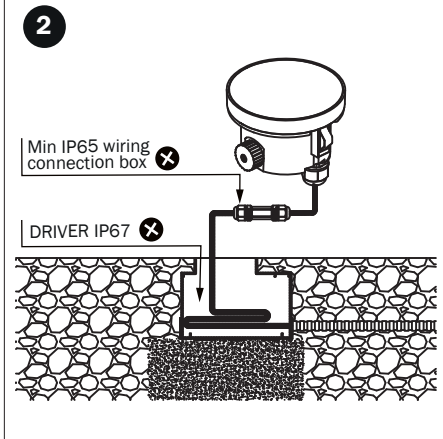
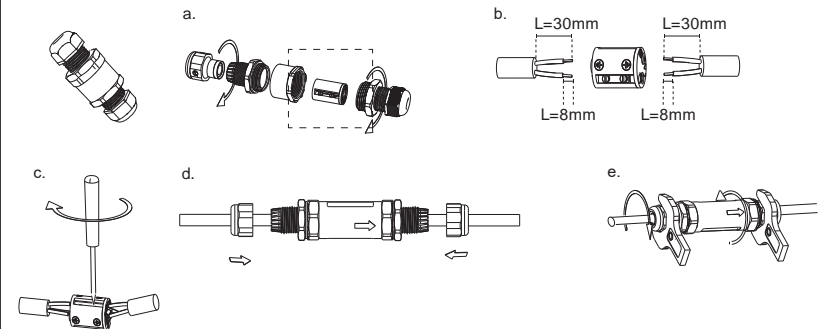

LIGHT SOURCE - FUENTE DE LUZ

ref. 71701 OSRAM SSL 4W 3000K 13° 462Lm
ref. 71702 OSRAM SSL 8W 3000K 13° 924Lm

TECHNICAL FEATURES - CARACTERÍSTICAS TÉCNICAS

	DRIVER IP67 NO INCL 24Vdc 100V-240V max 20W MBTS			IP67	IK09	 210Kg 2059,4N	0,5m H05RN-F 2x1,0mm2-Tz	Stainless Steel 316L	Available environment temperature -20°~40°C	
--	--	--	--	-------------	-------------	------------------------------------	--------------------------------	----------------------------	--	--