

731622 - Arlux



**Spot Led encastré Onyx R2 Arlux -
Rond - 6W - 4000K - IP20 - ø120mm -
Blanc**

Réf 731622

8.38€^{TTC*}

Voir le produit : <https://www.domomat.com/61274-spot-led-encastre-onyx-r2-arlux-rond-6w-4000k-ip20-o120mm-blanc-arlux-731622.html>



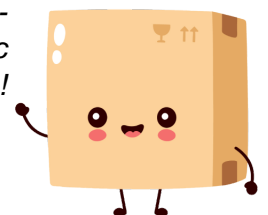

*Le produit Spot Led encastré Onyx R2 Arlux - Rond - 6W - 4000K - IP20 - ø120mm -
Blanc*



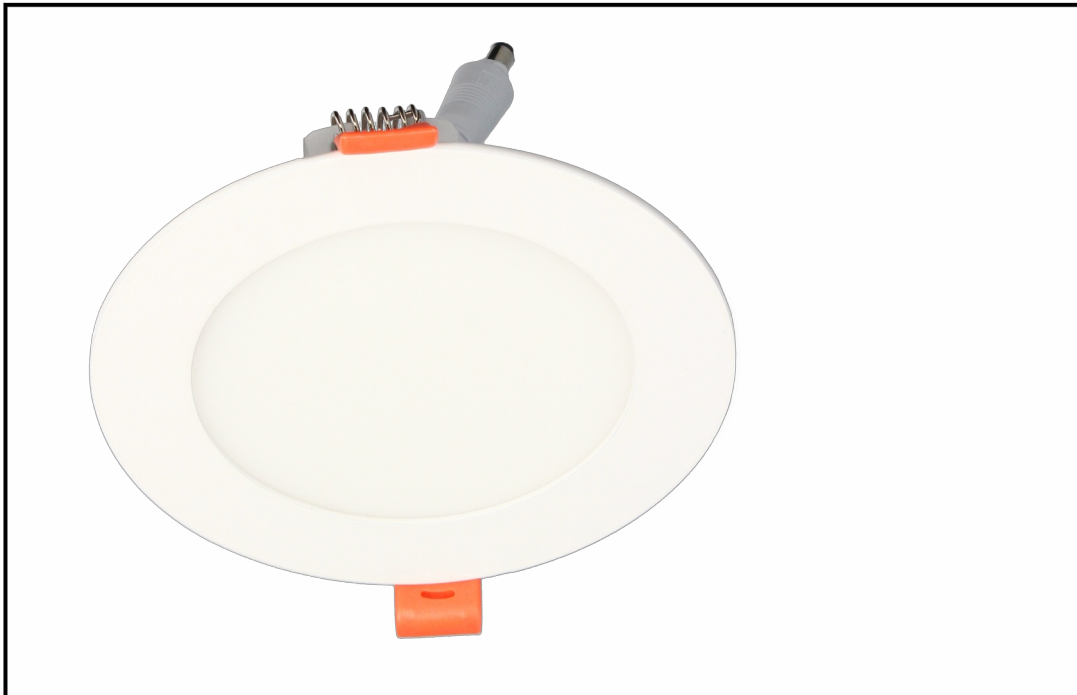



est en vente chez Domomat !

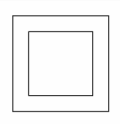

FR: Spot encastré Onyx R2
 EN: Downlight Onyx R2
 DE: Einbauleucht Onyx R2
 IT: Spot da incasso Onyx R2
 ES: Lugar empotrado Onyx R2
 PL: Plamka świecąca utwierdzić Onyx R2



 3 ANS / 3 YEARS / 3 ANNI / 3 ANNI / 3 ANNI	30000h
SMD 2835	 100°
 4-5m ²	CRI > 80
 IP20	
220-240V	
ALU	CE

					
3297027316222	6W	580lm	4000K	11mm	12x2 cm

SPOT ENCASTRABLE

580 lumens
6W

4000K
Température de couleur
NEUTRE

x1
4-5m²



Série ONYX R2

LEDS INTÉGRÉS

ArLUX

