

731626 - Arlux



**Spot Led encastré Onyx R2 Arlux -
Rond - 18W - 4000K - IP20 - ø225mm
- Blanc**

Réf 731626

14.27€^{TTC*}

Voir le produit : <https://www.domomat.com/61276-spot-led-encastre-onyx-r2-arlux-rond-18w-4000k-ip20-o225mm-blanc-arlux-731626.html>



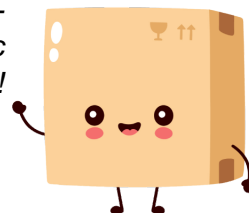

*Le produit Spot Led encastré Onyx R2 Arlux - Rond - 18W - 4000K - IP20 - ø225mm -
Blanc*







est en vente chez Domomat !

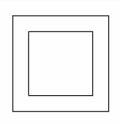

- FR: Spot encastré Onyx R2
- EN: Downlight Onyx R2
- DE: Einbauleucht Onyx R2
- IT: Spot da incasso Onyx R2
- ES: Lugar empotrado Onyx R2
- PL: Plamka świecąca utwierdzić Onyx R2



	30000h
SMD 2835	 100°
 5-6m²	CRI > 80
 IP20	
220-240V	
ALU	CE

					
3297027316260	18W	1550lm	4000K	21mm	22,5x2 cm

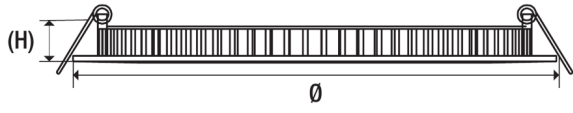
<p>SPOT ENCASTRABLE</p> <p>1550 lumens 18W</p> <p>BLANC NEUTRE 4000K Température de couleur</p> <p>x1 5-6m²</p>  <p>Série ONYX R2</p> <p>LEDS INTÉGRÉS</p> <p>ArLUX</p>	
---	--