

731628 - Arlux



**Spot Led encastré Onyx R2 Arlux -
Rond - 24W - 4000K - IP20 - ø300mm
- Blanc**

Réf 731628

20.69€^{TTC*}

Voir le produit : <https://www.domomat.com/61279-spot-led-encastre-onyx-r2-arlux-rond-24w-4000k-ip20-o300mm-blanc-arlux-731628.html>



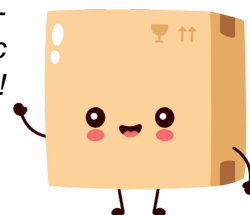

Le produit Spot Led encastré Onyx R2 Arlux - Rond - 24W - 4000K - IP20 - ø300mm - Blanc







est en vente chez Domomat !

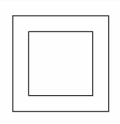

- FR: Spot encastré Onyx R2
- EN: Downlight Onyx R2
- DE: Einbauleucht Onyx R2
- IT: Spot da incasso Onyx R2
- ES: Lugar empotrado Onyx R2
- PL: Plamka świecąca utwierdzić Onyx R2



	30000h
SMD 2835	 100°
 6-7m ²	CRI > 80
 IP20	
220-240V	
ALU	CE

					
3297027316284	24W	2050lm	4000K	285mm	30x2 cm

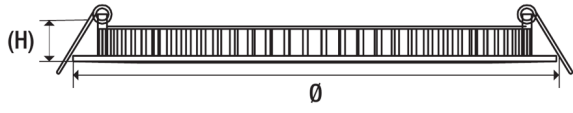
<p>SPOT ENCASTRABLE</p> <div style="display: flex; justify-content: space-around; align-items: center;"> <div style="border: 1px solid black; border-radius: 50%; padding: 5px; text-align: center;">2050 lumens 24W</div> <div style="border: 1px solid black; border-radius: 50%; padding: 5px; text-align: center;">BLANC NEUTRE 4000K Température de couleur</div> <div style="border: 1px solid black; border-radius: 50%; padding: 5px; text-align: center;">x1 6-7m²</div> </div>  <div style="display: flex; justify-content: space-between; align-items: center; margin-top: 10px;"> <div style="border: 1px solid black; padding: 2px; font-size: 8px;">Série ONYX R2</div> <div style="border: 1px solid black; padding: 2px; font-size: 8px;">LED INTÉGRÉS</div> <div style="font-size: 12px;">ArLUX</div> </div>	
---	--