

## 93120809 - Tungstram



**Ampoule LED Value A60 Tungstram -  
4.9W - E27 - 6500K**

Réf 93120809

**2.40€<sup>TTC\*</sup>**

Voir le produit : <https://www.domomat.com/64060-ampoule-led-value-a60-tungstram-49w-e27-6500k-tungstram-93120809.html>

*Le produit Ampoule LED Value A60 Tungstram - 4.9W - E27 - 6500K  
est en vente chez Domomat !*

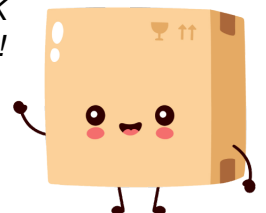

# LED VALUE SNOWCONE

4.9W, 8.8W, 9.6W, 13.2W



DATA SHEET

## Product information

Tungsramp introduces its new range of 4 highly competitive LED GLS products available in 3 colour temperatures. Consuming only 4.9W and 8.8W, 9.6W and 13.2W they are a fantastic energy saving alternative to traditional GLS lamps with new, high quality aesthetics.

## Features & benefits

- 15.000 hours life time L70
- Colour temperatures from 2700K, 4000K and 6500K
- Smooth light distribution
- Beam angle 180° and 200°
- "E", "F" Energy Class
- 100% retro-fit
- CE marked and Ecodesign compliant
- Warranty: 2 years with maximum 8 000 burning hours according to the Tungsramp Standard Warranty conditions

## Application areas



Hospitality



Household



Retail

## Standards

EN 55015:	Limits and methods of measurement of radio disturbance characteristics of electrical lighting
EN 61547:	Equipment for general lighting purposed EMC immunity requirements
EN 61000-3-3:	Limitation of voltage fluctuations and flicker in low voltage supply systems (equipment rated current $\leq 16A$ )
EN 61000-3-2:	Limits - Limits for harmonic current emissions (equipment input $\leq 16 A$ per phase)
IEC 62471:	Photobiological safety of lamps and lamp systems
IEC 60061:	Lamp Caps and holders together with gauges for the control of interchangeability and safety
EN 62560:	Self-ballasted lamps for general lighting services by voltage $> 50V$ - safety specification
EN 62493:	Assessment of lighting equipment related to human exposure to electromagnetic fields

# Specification summary

Product Code	Product code Direct Shipment	Product Description	Nominal /Rated Power (W)	Replacement Watt (W)	Nominal/ Rated Lumens (lm)	Nominal/ Rated Life (L70/B50 hours)	CCT (K)	CRI (Ra)	Cap/Base	EEC	Pack Qty
<b>Single Pack</b>											
93120800	93120776	LED VALUE A60 4.9W 827 B22 TU	4,9	40	470	15000	2700	80	B22	F	12
93120808	93120784	LED VALUE A60 4.9W 827 E27 TU	4,9	40	470	15000	2700	80	E27	F	12
93120820	93120796	LED VALUE A60 4.9W 840 B22 TU	4,9	40	470	15000	4000	80	B22	F	12
93120821	93120797	LED VALUE A60 4.9W 840 E27 TU	4,9	40	470	15000	4000	80	E27	F	12
93120801	93120777	LED VALUE A60 4.9W 865 B22 TU	4,9	40	470	15000	6500	80	B22	F	12
93120809	93120785	LED VALUE A60 4.9W 865 E27 TU	4,9	40	470	15000	6500	80	E27	F	12
93120802	93120778	LED VALUE A60 8.8W 827 B22 TU	8,8	60	806	15000	2700	80	B22	F	12
93120810	93120786	LED VALUE A60 8.8W 827 E27 TU	8,8	60	806	15000	2700	80	E27	F	12
93120822	93120798	LED VALUE A60 8.8W 840 B22 TU	8,8	60	806	15000	4000	80	B22	F	12
93120823	93120799	LED VALUE A60 8.8W 840 E27 TU	8,8	60	806	15000	4000	80	E27	F	12
93120803	93120779	LED VALUE A60 8.8W 865 B22 TU	8,8	60	806	15000	6500	80	B22	F	12
93120811	93120787	LED VALUE A60 8.8W 865 E27 TU	8,8	60	806	15000	6500	80	E27	F	12
93120804	93120780	LED VALUE A60 9.6W 827 B22 TU	9,6	75	1055	15000	2700	80	B22	F	12
93120812	93120788	LED VALUE A60 9.6W 827 E27 TU	9,6	75	1055	15000	2700	80	E27	F	12
93120816	93120792	LED VALUE A60 9.6W 840 B22 TU	9,6	75	1055	15000	4000	80	B22	F	12
93120817	93120793	LED VALUE A60 9.6W 840 E27 TU	9,6	75	1055	15000	4000	80	E27	F	12
93120805	93120781	LED VALUE A60 9.6W 865 B22 TU	9,6	75	1055	15000	6500	80	B22	F	12
93120813	93120789	LED VALUE A60 9.6W 865 E27 TU	9,6	75	1055	15000	6500	80	E27	F	12
93120806	93120782	LED VALUE A60 13.2W 827 B22 TU	13,2	100	1521	15000	2700	80	B22	E	12
93120814	93120790	LED VALUE A60 13.2W 827 E27 TU	13,2	100	1521	15000	2700	80	E27	E	12
93120818	93120794	LED VALUE A60 13.2W 840 B22 TU	13,2	100	1521	15000	4000	80	B22	E	12
93120819	93120795	LED VALUE A60 13.2W 840 E27 TU	13,2	100	1521	15000	4000	80	E27	E	12
93120807	93120783	LED VALUE A60 13.2W 865 B22 TU	13,2	100	1521	15000	6500	80	B22	E	12
93120815	93120791	LED VALUE A60 13.2W 865 E27 TU	13,2	100	1521	15000	6500	80	E27	E	12
-	93121800	LED VALUE A60 4.9W 827 E27 TU SADS	4,9	40	470	15000	2700	80	E27	F	12
-	93121801	LED VALUE A60 4.9W 865 E27 TU SADS	4,9	40	470	15000	6500	80	E27	F	12
-	93121802	LED VALUE A60 8.8W 827 E27 TU SADS	8,8	60	806	15000	2700	80	E27	F	12
-	93121803	LED VALUE A60 8.8W 865 E27 TU SADS	8,8	60	806	15000	6500	80	E27	F	12
-	93121804	LED VALUE A60 9.6W 827 E27 TU SADS	9,6	75	1055	15000	2700	80	E27	F	12
-	93121805	LED VALUE A60 9.6W 865 E27 TU SADS	9,6	75	1055	15000	6500	80	E27	F	12
-	93121806	LED VALUE A60 13.2W 827 E27 TU SADS	13,2	100	1521	15000	2700	80	E27	E	12
-	93121807	LED VALUE A60 13.2W 865 E27 TU SADS	13,2	100	1521	15000	6500	80	E27	E	12
<b>Twin Pack</b>											
93120824	-	LED VALUE A60 8.8W 827 B22 TU 2BX	8,8	60	806	15000	2700	80	B22	F	8
93120825	-	LED VALUE A60 8.8W 827 E27 TU 2BX	8,8	60	806	15000	2700	80	E27	F	8

## Energy efficiency class (A-G)\*



## Common attributes

- Colour Rendering Index 80
- Input Voltage: 220-240V
- Warm up time: Instant on
- Life time L70 15 000 hours
- Power factor: >0.5 and >0.7
- Ambient temperature range -10° C to +40° C
- Line Freq: 50/60Hz
- Switching Cycle 50 000 times
- Color consistency < 6 SDCM

## Operation and maintenance

- Store and use the lamps the same way as traditional lamps.
- Check your fixtures are properly wired and don't deliver voltage spike to lamps causing overheating/failure.
- Lamps should be kept free from contamination.
- Good condition of the lamp-holder contacts is important to ensure proper operation of lamp.
- Ensure lamp is cool before removing.
- Switch off mains supply before installing/removing lamp.
- Not for use in totally enclosed recessed fixtures

## Recommended operation temperature

Ths Max for L70 90° C  
Ths Max for B50 90° C

Thermal test point



## Packaging image



## Dimensions (mm)

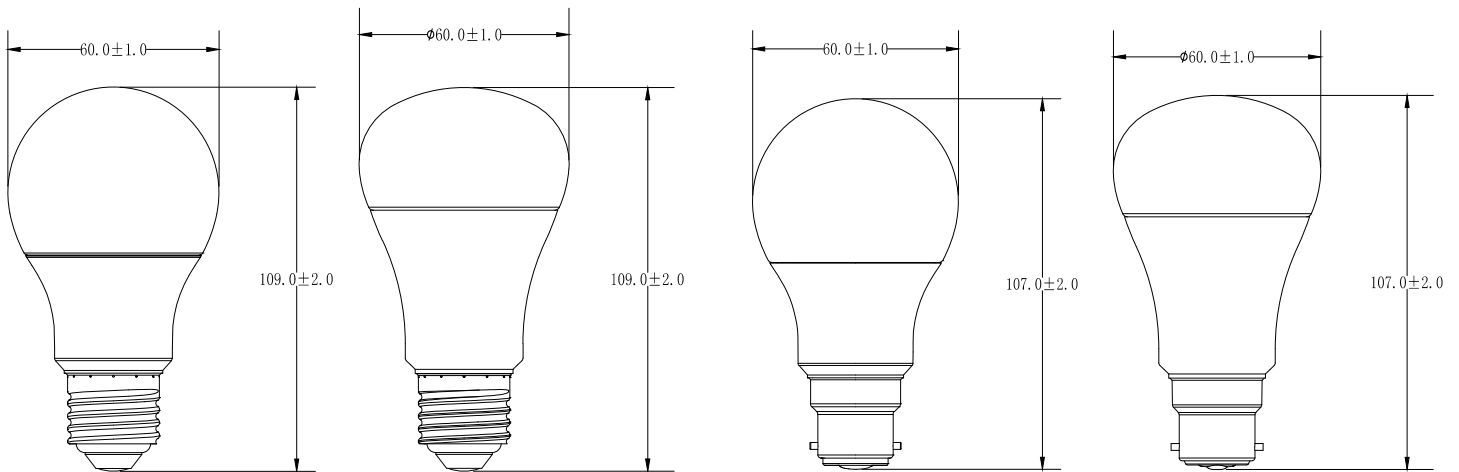

4.9W, 8.8W and  
9.6W E27

13.2W E27

4.9W, 8.8W and  
9.6W B22

13.2W B22

# Spectral distributions

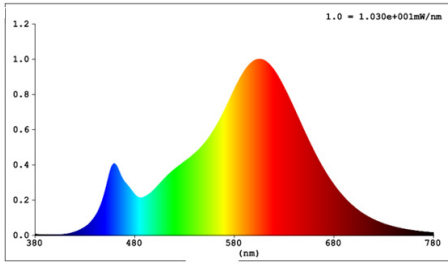

4.9W 2700K

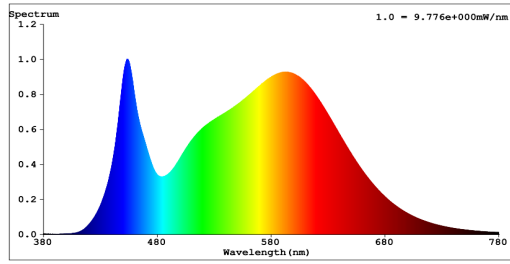

4.9W 4000K

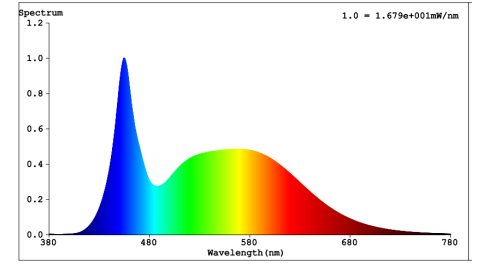

4.9W 6500K

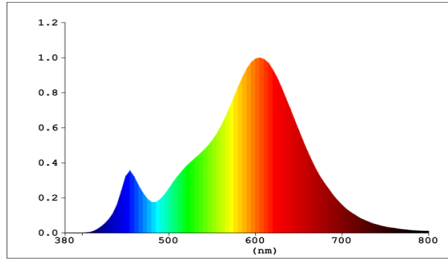

8.8W 2700K

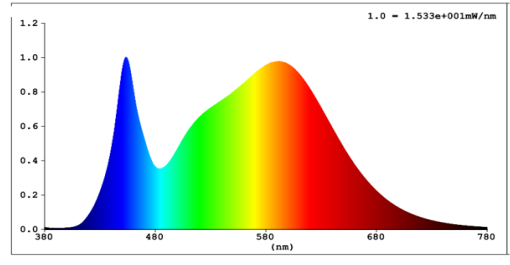

8.8W 4000K

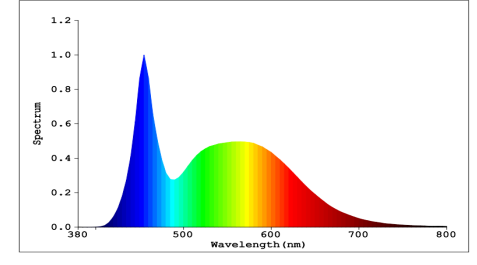

8.8W 6500K

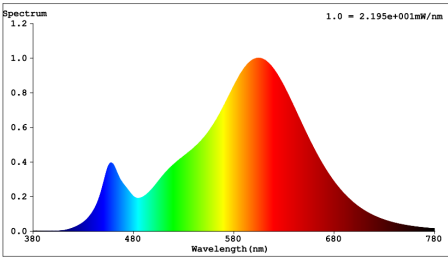

9.6W 2700K

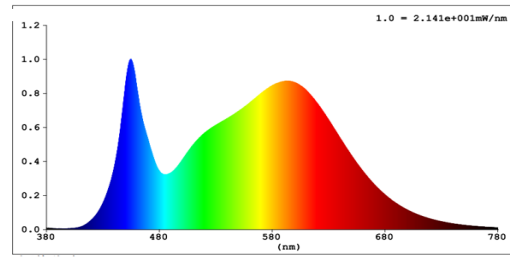

9.6W 4000K

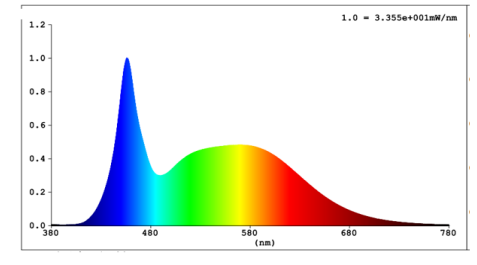

9.6W 6500K

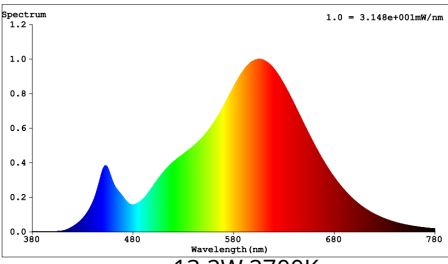

13.2W 2700K

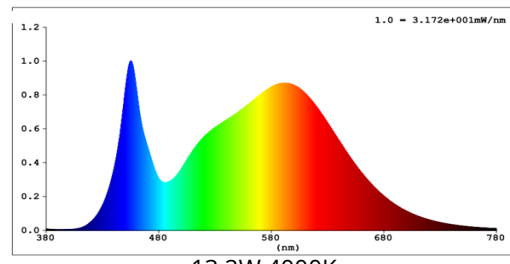

13.2W 4000K

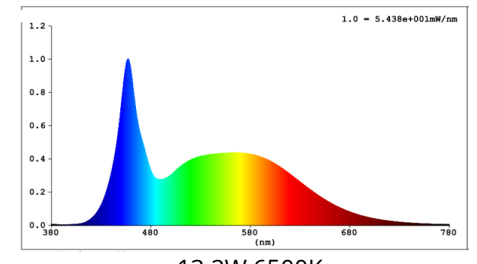

13.2W 6500K

All values 180-400nm are 0