

## B01725 | Iboco



**Angle intérieur variable 70° à 120°  
NIAV - Pour goutte 100x40mm -  
Blanc**

Réf B01725

**32.09€<sup>TTC\*</sup>**

Voir le produit : <https://www.domomat.com/3539-angle-interieur-variable-70-a-120-niav-pour-goutte-100x40mm-blanc-iboco-b01725.html>

*Le produit Angle intérieur variable 70° à 120° NIAV - Pour goutte 100x40mm - Blanc est en vente chez Domomat !*



**TA-E** Goulottes de distribution

**Goulotte de distribution non cloisonnable**

Pour le cheminement de câbles d'une seule nature ou de fluides.

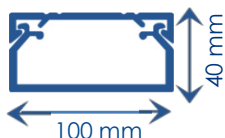
**DESCRIPTIF TECHNIQUE**

Matière première	PVC classé M1
Couleur	Blanc RAL 9010
Longueur	Standard 2 m (livrée socle + couvercle)
Socle	<ul style="list-style-type: none"> <li>Perforé, trous ronds facilitant la fixation</li> <li>Symétrique, pas de sens de montage (livré filmé)</li> </ul>
Couvercle	Liserés de finition (livré filmé)
Forme	Rectangulaire permettant tous types de cheminements
Composants	<ul style="list-style-type: none"> <li>Gamme complète de composants système</li> <li>Supports d'appareillages 45x45 en clipsage direct</li> </ul>

**COMPOSANTS**

Agrafe de retenue de câbles	Angle intérieur variable 70° à 120°	Angle extérieur variable 70° à 120°	Angle plat	Embout	Té de dérivation avec réducteur	Joint de couvercle	Embout passage de mur	Boîte de dérivation	Joint de sol rehausseur
<b>TR-E</b>	<b>NIAV</b>	<b>NEAV</b>	<b>NPAN</b>	<b>LAN</b>	<b>NTAN</b>	<b>GAN</b>	<b>RQM</b>	<b>SDN</b>	<b>DST</b> <small>longueur std 2 m</small>
07714	01725	01709	01741	00873	01757	00887	01776	01769	01913

**SUPPORTS D'APPAREILLAGES 45x45**

Couvercle supplémentaire	Joint de socle éclisse	2 modules compacts	4 modules compacts
<b>COV-N</b>	<b>JSE</b>	<b>PDA-45N</b>	<b>PDA-M4</b>
01796	00851	00514	00519

**OUTILLAGE**

Corner	Discover
<b>CORNER</b>	<b>DISCOVER</b>
03001	06472

**OUTILS DE FIXATION**

Colle	Pistolet à colle
<b>DUCTACOL</b>	<b>BC</b>
02550	02500

**CAPACITE MAXIMALE THEORIQUE EN CABLES**

A	U1000	TELEPHONE	INFORMATIQUE		
	RO2V 3G2,5 Ø 12,5	4 PAIRES 6/10 Ø 6	Non blindé cat 5E Ø 5	Blindé cat 5E Ø 5,9	Blindé cat 6D Ø 6,8
<b>A</b>	<b>A</b>	<b>A</b>	<b>A</b>	<b>A</b>	<b>A</b>
15	68	102	72	53	

**NORMES**

 Classification CSTB : PVC classé M1  
 Certifiée norme EN 50085-1   
 Certifiée norme EN 50085-2-1  
 Ouverture du couvercle : à l'aide d'un outil  
 Marquage produits : CE

**TA-E** Goulottes de distribution

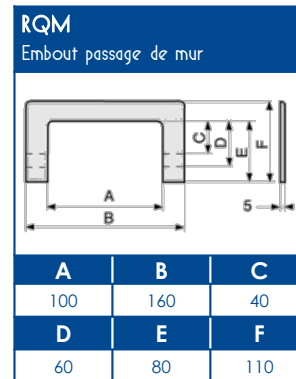
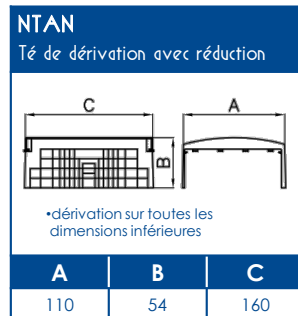
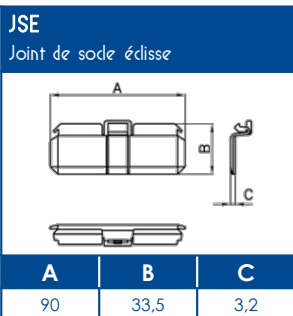
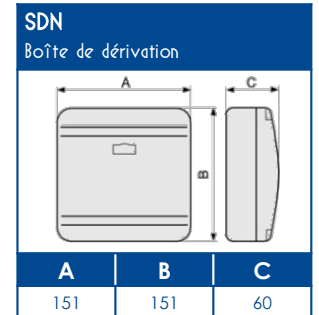
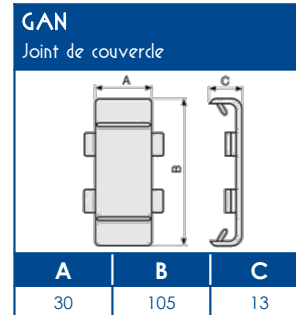
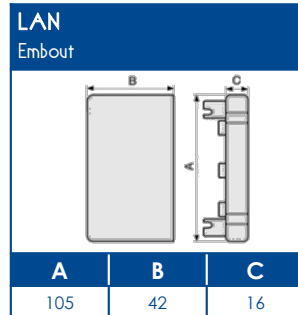
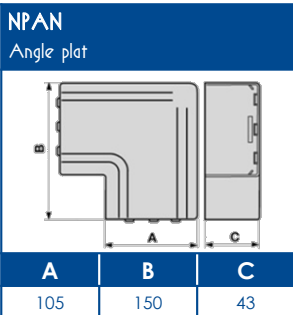
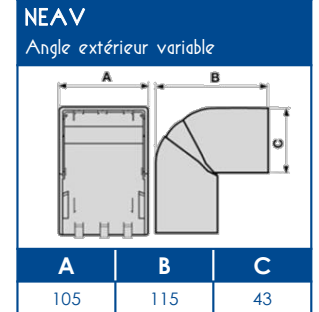
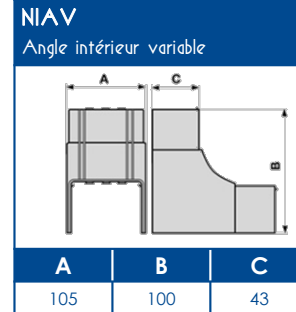
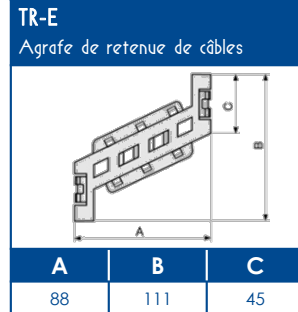
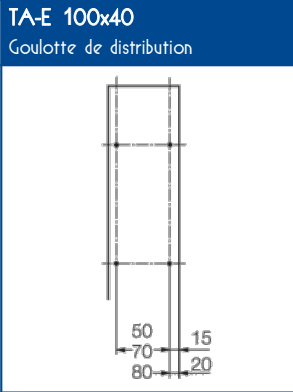
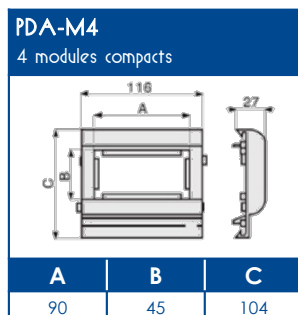
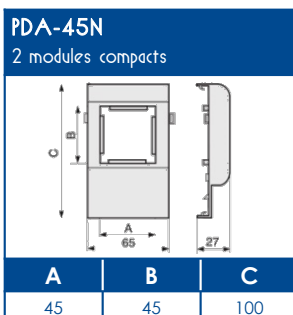
**SCHEMAS ET COTES (mm)**

**SUPPORTS D'APPAREILLAGES 45x45**

**COMPATIBILITE APPAREILLAGES 45x45**

LEGRAND	PW	SCHNEIDER	HAGER	3M
Mosaïc™	Espace Liberté™	Alvaïs quadra™	Systo™	Volution™

Compatible avec tous les appareillages standard 45x45