

## B01785 | Iboco



**Goulotte de distribution TA-G  
80x60mm - Barre de 2m - 1  
compartment - Blanc**

Réf B01785

**37.14€<sup>TTC\*</sup>**

Voir le produit : <https://www.domomat.com/34685-goulotte-de-distribution-ta-g-80x60mm-barre-de-2m-1-compartment-blanc-iboco-b01785.html>

*Le produit Goulotte de distribution TA-G 80x60mm - Barre de 2m - 1 compartiment - Blanc est en vente chez Domomat !*

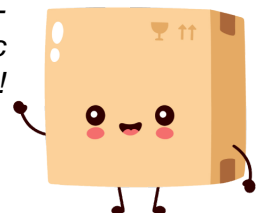

**TA-G** Goulottes de distribution cloisonnables

**Goulotte de distribution appareillable et cloisonnable.**

Pour la distribution des courants forts et faibles et la réalisation de petites installations.

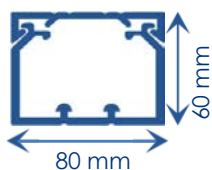
**DESCRIPTIF TECHNIQUE**

Matière première	PVC classé M1
Couleur	Blanc RAL 9010
Longueur	Standard 2 m (livrée socle + couvercle)
Socle	<ul style="list-style-type: none"> <li>Perforé, trous ronds et trous oblongs facilitant la fixation</li> <li>Symétrique, pas de sens de montage (livré filmé)</li> </ul>
Compartiment	2 guides de fond pour un cloisonnement 1/3 – 2/3 ou le montage de 2 cloisons pour la réalisation de 3 compartiments
Couvercle	Liserés de finition (livré filmé)
Forme	Rectangulaire permettant tous types de cheminements
Composants	<ul style="list-style-type: none"> <li>Gamme complète de composants système</li> <li>Support pour appareillages 45x45 en clipsage direct</li> </ul>

**COMPOSANTS**

Cloison de séparation	Agrafe de retenue de câbles	Angle intérieur variable 70° à 120°	Angle extérieur variable 70° à 120°	Angle plat	Embout	Té de dérivation avec réducteur	Joint de couvercle	Embout passage de mur	Boîte de dérivation	Joint de sol rehausseur	Couvercle supp.
longueur std 2 m										Longueur std 2 m	Longueur std 2 m
<b>SEP-G</b>	<b>TR-E</b>	<b>NIAV</b>	<b>NEAV</b>	<b>NPAN</b>	<b>LAN</b>	<b>NTAN</b>	<b>GAN</b>	<b>RQM</b>	<b>SDN</b>	<b>DST</b>	<b>COV-N</b>
02415	07713	01728	01712	01744	00872	01760	00886	01775	01770	01913	01795

**SUPPORT D'APPAREILLAGE 45x45**

**OUTILLAGE**

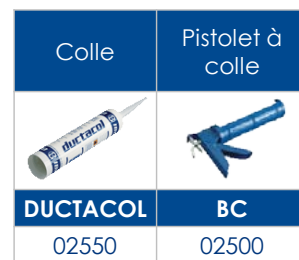
**FIXATION**

**CAPACITE MAXIMALE THEORIQUE EN CABLES**

U1000		TELEPHONE		INFORMATIQUE					
RO2V 3G2,5		4 PAIRES 6/10		Non blindé cat 5E		Blindé cat 5E		Blindé cat 6D	
A	B	A	B	A	B	A	B	A	B
14	6	65	26	90	40	67	28	51	23



**\*Résistance mécanique (IK10)**

**NORMES**

 Classification CSTB : PVC classé M1  
 Certifiée norme EN 50085-1  
 Certifiée norme EN 50085-2-1   
 Ouverture du couvercle : à l'aide d'un outil  
 Marquage produits : CE

Expert en cheminement de l'énergie

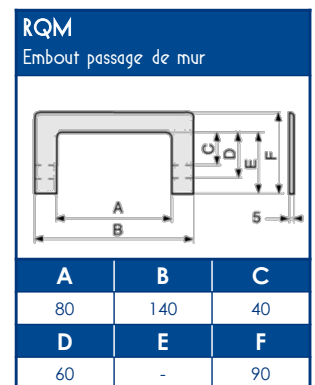
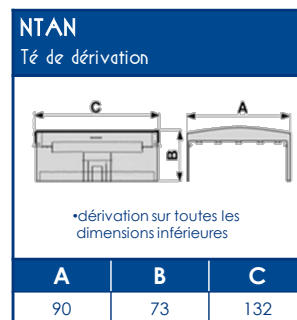
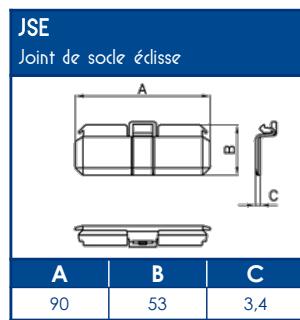
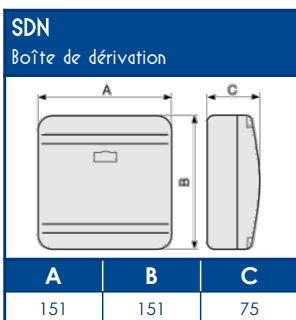
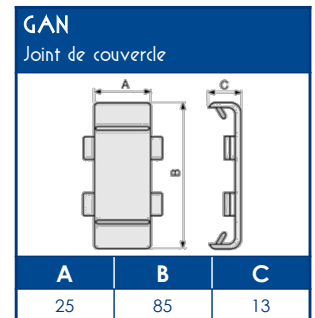
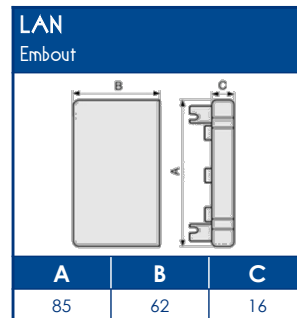
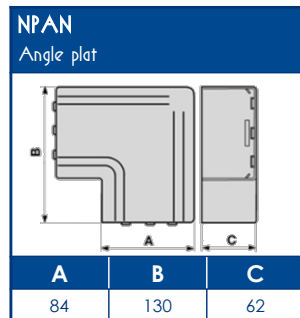
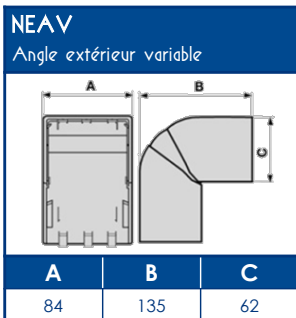
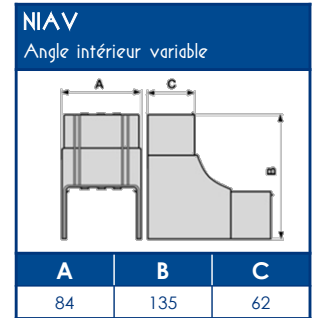
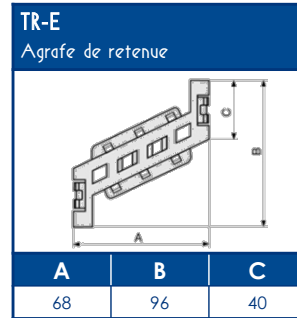
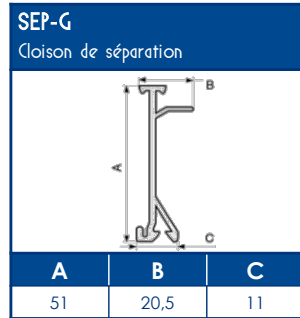
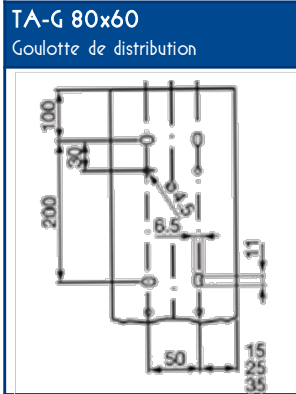
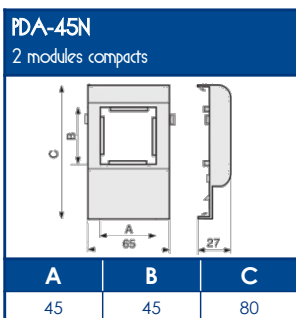
**TA-G** Goulottes de distribution cloisonnables

**SCHEMAS ET COTES (mm)**

**SUPPORT D'APPAREILLAGE  
MODULE 45**

**COMPATIBILITE APPAREILLAGES 45x45**

LEGRAND	PW	SCHNEIDER	HAGER	3M
Mosaïc™	Espace Liberté™	Alvaïs quadra™	Systo™	Volution™

Compatible avec tous les appareillages standard 45x45