

B01789 | Iboco



Goulotte de distribution TA-G 200x60mm - Barre de 2m - 1 compartiment - Blanc

Réf B01789 **83.66€^{TTC*}**

<https://www.domomat.com/34690-goulotte-de-distribution-ta-g-200x60mm-barre-de-2m-1-compartiment-blanc-iboco-b01789.html>



Couvercle supplémentaire COV-N - Pour goulotte TA-E et TA-G - Blanc

Réf B01799 **22.55€^{TTC*}**

<https://www.domomat.com/34884-couvercle-supplementaire-cov-n-pour-goulotte-ta-e-et-ta-g-blanc-iboco-b01799.html>



Joint de socle éclisse JSE - Pour goulotte TA-E et TA-G

Réf B00852 **7.49€^{TTC*}**

<https://www.domomat.com/34897-joint-de-socle-eclisse-jse-pour-goulotte-ta-e-et-ta-g-iboco-b00852.html>

*Retrouvez tous les produits de la catégorie
Goulottes de distribution Iboco
chez Domomat !*

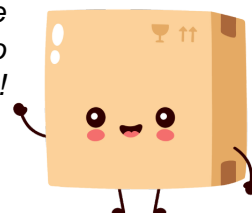

* : Prix sur le site Domomat.com au 23/04/2024. Le prix est susceptible d'être modifié.

TA-G

 Goulottes
de distribution cloisonnables

Goulotte de distribution mono-couvercle appareillable et cloisonnable.

Pour la distribution des courants forts et faibles et la réalisation de petites installations.

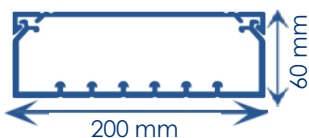
DESCRIPTIF TECHNIQUE

Matière première	PVC classé M1
Couleur	Blanc RAL 9010
Longueur	Standard 2 m (livrée socle + couvercle)
Socle	<ul style="list-style-type: none"> Perforé, trous ronds et trous oblongs facilitant la fixation Symétrique, pas de sens de montage (livré filmé)
Compartiments	6 guides de fond pour un cloisonnement au juste besoin
Couvercle	Liserés de finition (livré filmé)
Forme	Rectangulaire permettant tout type de cheminements
Composants	<ul style="list-style-type: none"> Gamme complète de composants système Support pour appareillages 45x45 en clipsage direct

COMPOSANTS

Cloison de séparation	Agrafe de retenue de câbles	Angle intérieur variable 70° à 120°	Angle extérieur variable 70° à 120°	Angle plat	Embout	Té de dérivation avec réducteur	Joint de couvercle	Boîte de dérivation	Joint de sol rehausseur	Couvercle supplémentaire	Joint de socle éclisse
longueur std 2 m									Longueur std 2 m	Longueur std 2 m	
SEP-G	TR-E	NIAV	NEAV	NPAN	LAN	NTAN	GAN	SDN	DST	COV-N	JSE
02415	07717	01732	01716	01748	00881	01764	00890	01771	01913	01799	00852

SUPPORT D'APPAREILLAGES
MODULE 45

2x4 modules compacts

PDA-M8

00545

OUTILLAGE

Corner	Discover
CORNER	DISCOVER
03001	06472

FIXATION

Colle	Pistolet à colle
DUCTACOL	BC
02550	02500

CAPACITE MAXIMALE THEORIQUE EN CABLES

U1000			TELEPHONE			INFORMATIQUE								
RO2V 3G2,5			4 PAIRES 6/10			Non blindé cat 5E			Blindé cat 5E			Blindé cat 6D		
A	B	C	A	B	C	A	B	C	A	B	C	A	B	C
23	12	15	110	61	75	165	87	114	110	61	78	86	44	58

***Résistance mécanique (IK10)**

1 longueur de 2 m

IK10

4 agrafes TR-E (tous les 50 cm)

NORMES

Classification CSTB : PVC classé M1

Certifiée norme EN 50085-1

Certifiée norme EN 50085-2-1



Ouverture du couvercle : à l'aide d'un outil

Marquage produits : CE

Expert en cheminement de l'énergie

TA-G

Goulottes de distribution cloisonnables



IP40



IK08 système



IK10 système



960° longueur



PVC M1



RoHS

SCHEMAS ET COTES (mm)

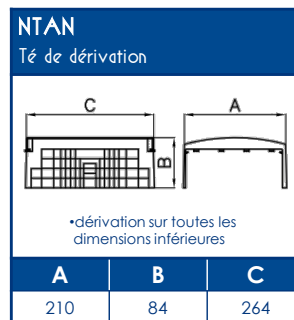
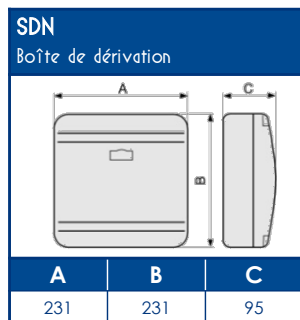
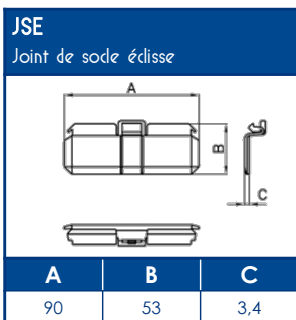
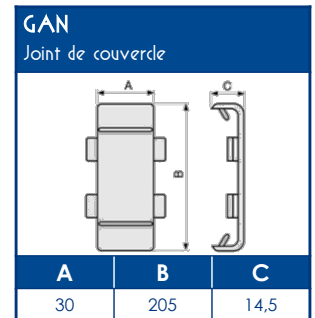
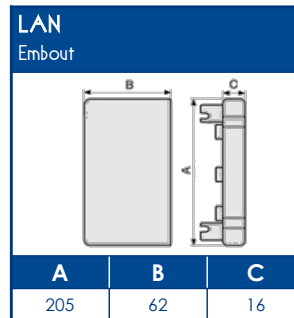
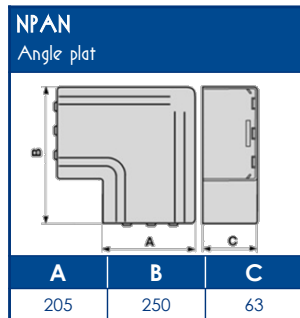
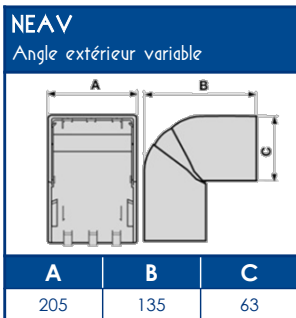
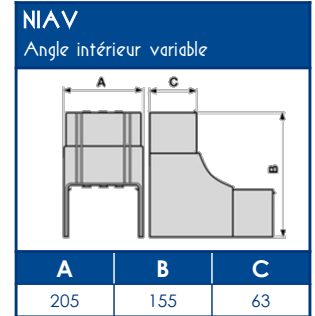
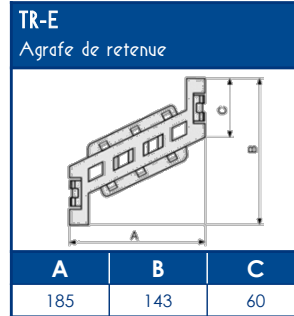
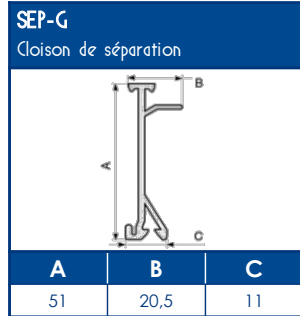
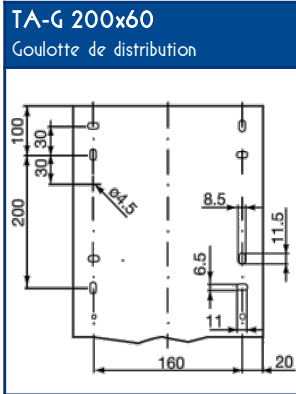
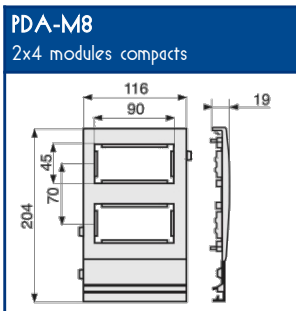
 SUPPORT D'APPAREILLAGES
MODULE 45

COMPATIBILITE APPAREILLAGES 45x45

LEGRAND	PW	SCHNEIDER	HAGER	3M
Mosaïc™	Espace Liberté™	Alvaïs quadra™	Systo™	Volution™

Compatible avec tous les appareillages standard 45x45