

LV429518 | Schneider Notice



**Cache borne - Pour disjoncteur
NSX100-250 - 4P**

Réf LV429518

15.72€^{TTC*}

Voir le produit : <https://www.domomat.com/38605-cache-borne-pour-disjoncteur-nsx100-250-4p-schneider-electric-lv429518.html>

*Le produit Cache borne - Pour disjoncteur NSX100-250 - 4P
est en vente chez Domomat !*

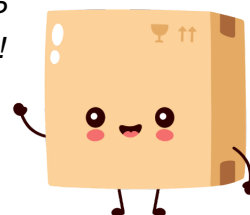

**Compact NSX100-250
FPower NSX / GV7**

Adapter for plug in base
Adaptateur pour socle
Adaptador zócalo

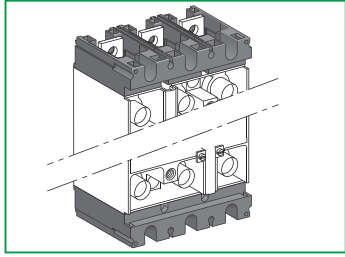

GHD16252AA-06

Schneider Electric Industries SAS

35, rue Joseph Monier
CS 30323
F - 92506 Rueil Malmaison Cedex

www.schneider-electric.com



© 2011 Schneider Electric.
All rights reserved.

IMPORTANT NOTE

- This device must be installed by a qualified electrician.
- We cannot accept any responsibility for failure to follow the instructions provided in this document.

REMARQUE IMPORTANTE

- L'installation de cet appareil doit être effectuée par des professionnels de l'électricité.
- Le non-respect des indications de la présente notice ne saurait engager la responsabilité du constructeur.

OBSERVACIÓN IMPORTANTE

- La instalación y mantenimiento de este aparato sólo debe ser realizado por electricistas profesionales.
- El fabricante no se hace responsable en caso de no cumplir con las indicaciones expuestas en este aviso.

重要注意事項

- 本装置必须由合格的电工进行安装。
- 我们不承担任何因未遵循本文档中的指南而导致的责任。

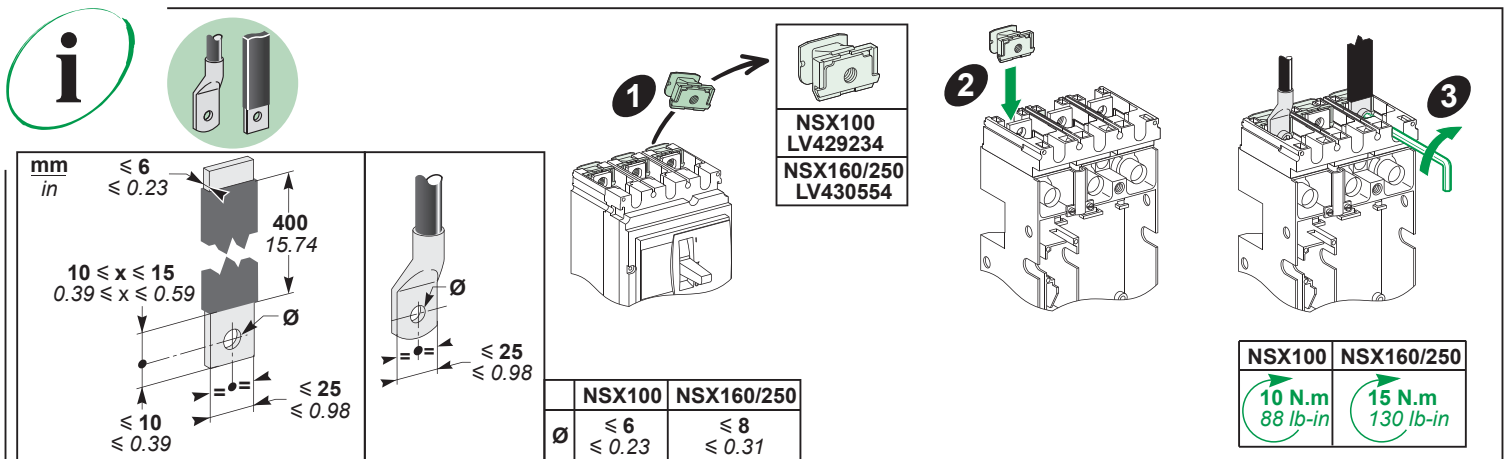
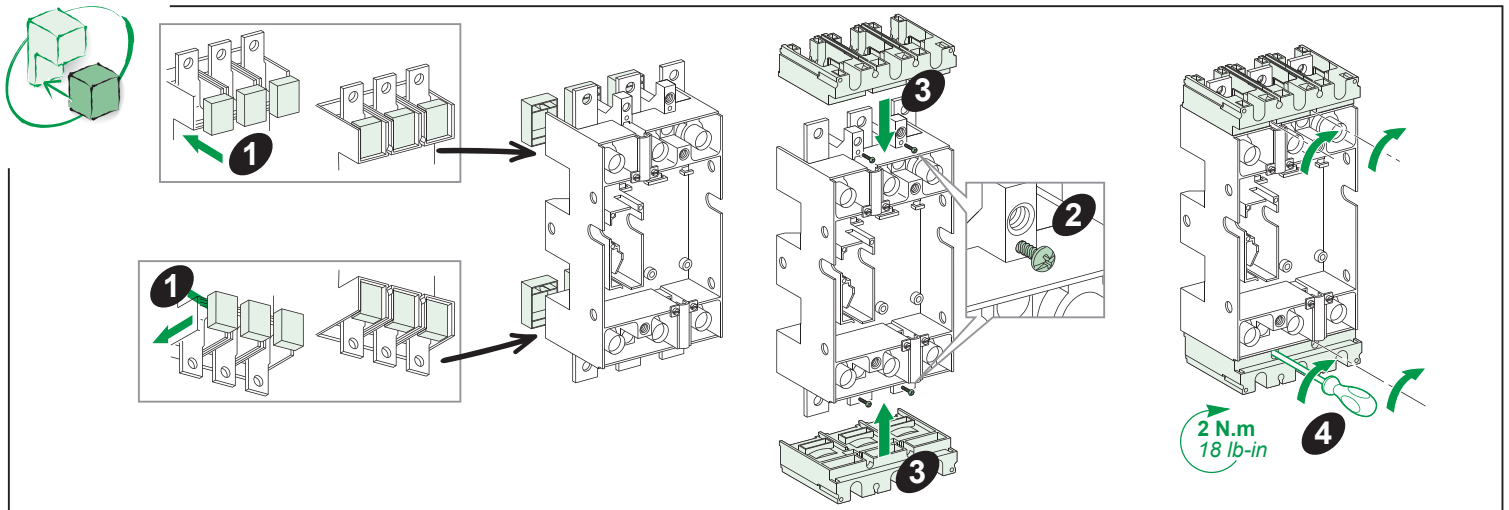
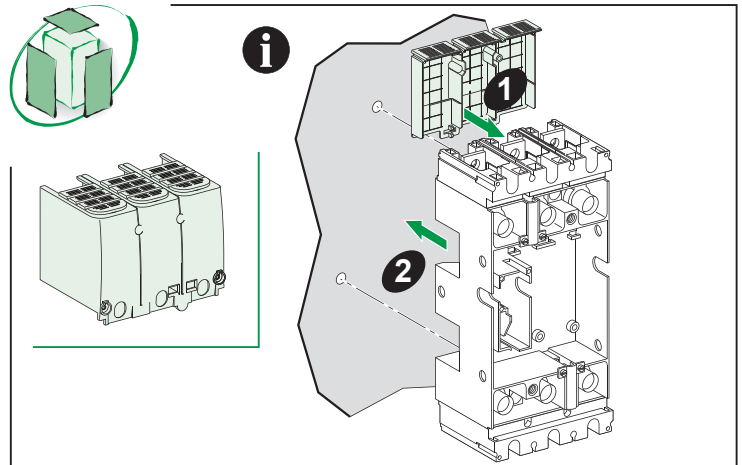
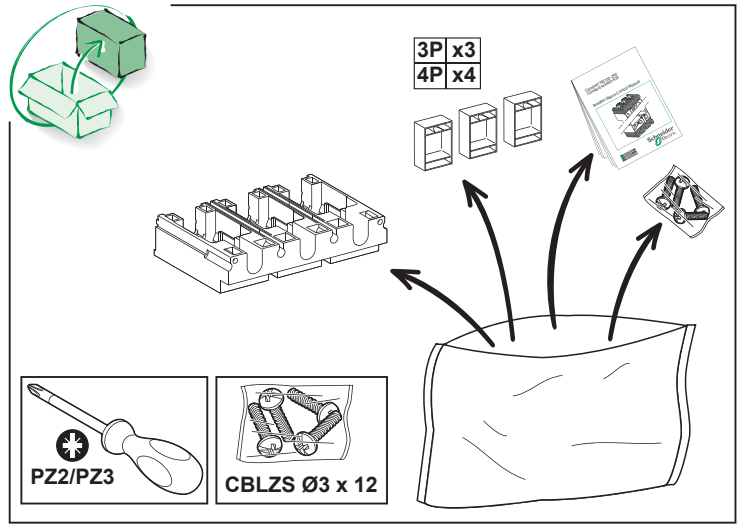

GHD16252AA-06

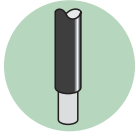
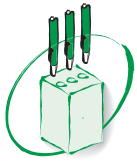

mm
in

NSX100/250

NSX100/250	
25 → 95 mm ²	120 → 185 mm ²
x2 LV429255	LV429247
x3 LV429227	LV429259
x4 LV429228	LV429260



Aluminium
Aluminium

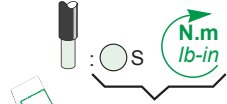

see instruction
1 cable / 2 cables connector

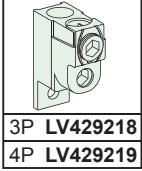
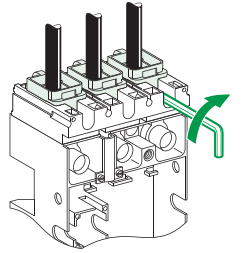

3P LV429218
4P LV429219

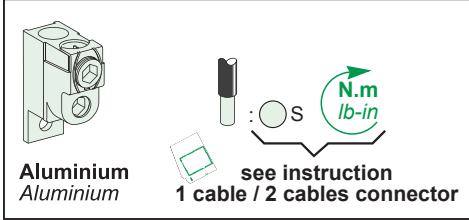

Aluminium
Aluminium

see instruction
1 cable / 2 cables connector

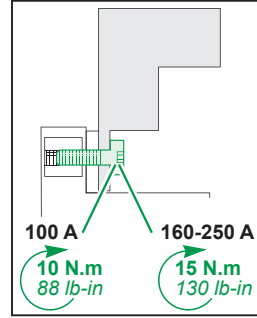

100 A
10 N.m
88 lb-in

160-250 A
15 N.m
130 lb-in

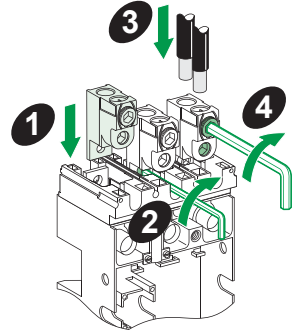

NSX100/160

NSX100/160	
1,5...95 mm ²	AWG 16...4/0
x2 LV429246	
x3 LV429242	
x4 LV429243	

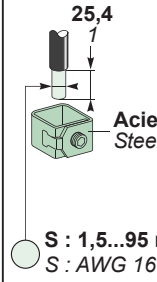

Acier
Steel

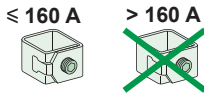

≤ 160 A

> 160 A

S : 1,5...95 mm² Cu / Al
S : AWG 16...4/0 Cu / Al

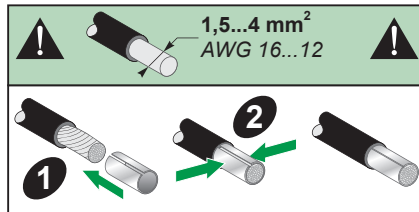

1,5...4 mm²
AWG 16...12

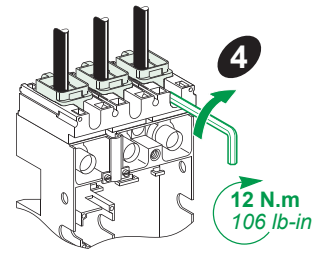
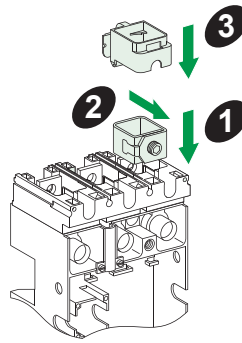

12 N.m
106 lb-in

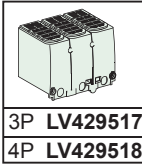

3P LV429517
4P LV429518

Mandatory U ≥ 500 V
Obligatoire U ≥ 500 V
Obligatorio U ≥ 500 V

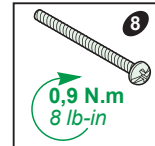
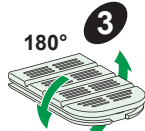
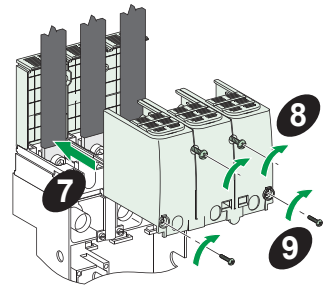
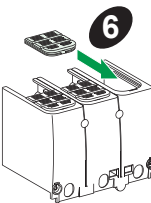
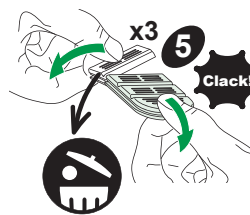
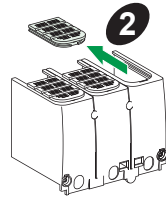
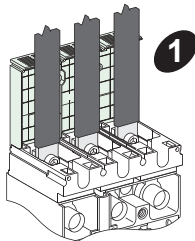

0,9 N.m
8 lb-in



1,2 N.m
10.5 lb-in

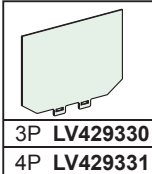

3P LV429330
4P LV429331

Mandatory U ≥ 500 V
Obligatoire U ≥ 500 V
Obligatorio U ≥ 500 V

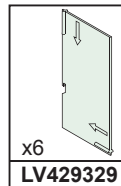
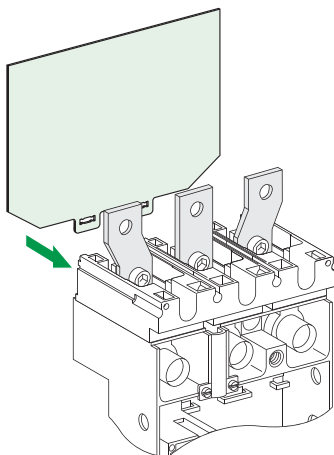

x6
LV429329

