

R809 | Comap



**Lot de 10 corps thermostatiques à
Kv fixe Comap - Droit Femelle - M28
- 3/8" - Métal**
Réf R809603

207.48€^{TTC*}

Voir le produit : <https://www.domomat.com/51971-lot-de-10-corps-thermostatiques-a-kv-fixe-comap-droit-femelle-m28-38-metal-comap-r809603.html>

*Le produit Lot de 10 corps thermostatiques à Kv fixe Comap - Droit Femelle - M28 - 3/8"
- Métal*

est en vente chez Domomat !

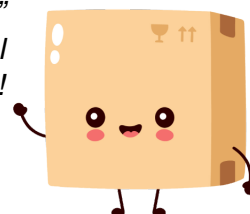



ROBINET THERMOSTATIQUE KV FIXE FIXOSAR

COMAP

DESCRIPTION

Robinet thermostatique de radiateur (RTH) pour régulation de la température et réglage du débit (Kv Fixosar).

VERSIONS

Fonctions	Kv fixe
Connexion à la tête	M28x1.5 - M30x1.5
Connexion au tube	Filetage ou taraudage
Connexion au radiateur	Métal / métal: 3/8", 1/2", 3/4" Ou avec 2 joints toriques : un sur le cône et l'autre sur le filet côté radiateur: 3/8" et 1/2"



016

Produit certifié
KEYMARK
selon EN215



AVANTAGES

- Produit utilisable dans les 2 sens de flux :
- Pas de bruit d'écoulement
- Pas de vibrations
- Pas de collage du mécanisme en cas de fermeture prolongée

CONCEPTION

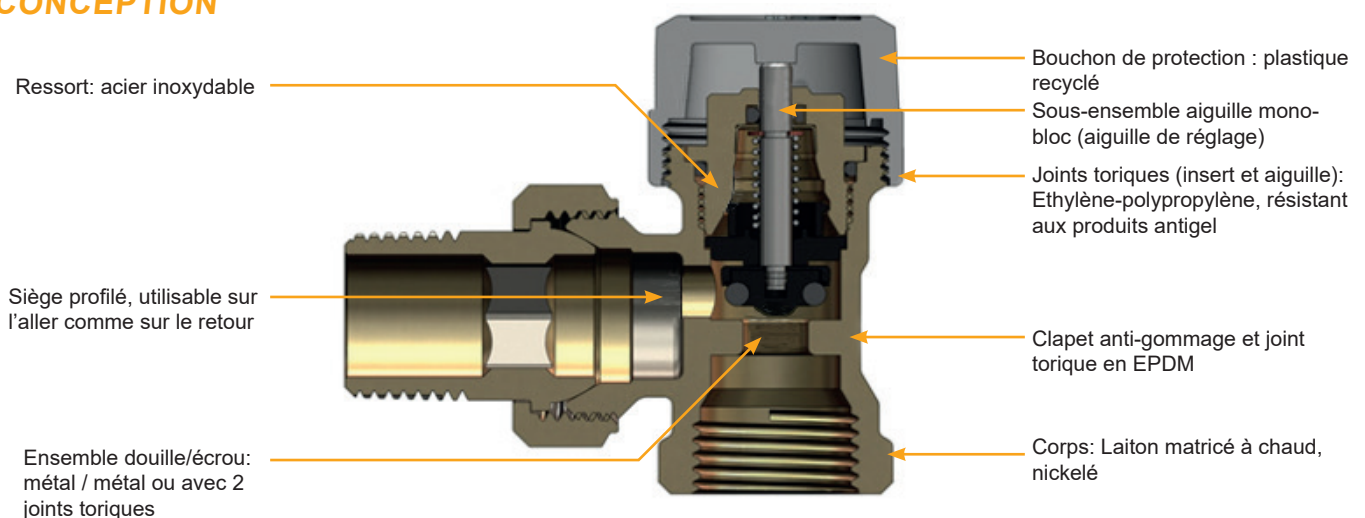

SPÉCIFICATIONS

Pour applications de chauffage à eau chaude standard, dans les conditions suivantes:

Pression d'utilisation Maximum : 10 bar

Température d'utilisation Maximum : 110 ° C

Différence de Pression Maximum : 0.6 bar



ROBINET THERMOSTATIQUE KV FIXE FIXOSAR

COMAP

DIMENSIONS

	Forme	Ref	M28/M30	G	g	B	L	Dmax
	Equerre	R808603 R808603B	M28	3/8"			49	20
		R808604 R808604B*		1/2"			53	23
		R808606		3/4"			63	26
		R804403	M30	3/8"			51,5	22,5
		R804404		1/2"			57,5	26,5
		R804406		3/4"			66	30
	Equerre	R808703 R808703B	M28	3/8"	M22 x 1.5	48	20	16
		R808704 R808704B		1/2"	M22 x 1.5	54	21	16
	Droit	R809603	M28	3/8"		75	28	
		R809604 R809604B* R809604Q		1/2"		82	32.5	
		R809606		3/4"		98	33.5	
		R805403	M30	3/8"		84.5	30	
		R805404		1/2"		94	33	
		R805406		3/4"		106	37	
	Droit	R809704 R809704B	M28	1/2"	M22 x 1.5	75	22	16



ROBINET THERMOSTATIQUE KV FIXE FIXOSAR

COMAP

	Forme	Ref	M28/M30	G	g	B	L	Dmax
	Equerre inverse	R807603	M28	3/8"		48	31.5	
		R807604 R807604Q		1/2"		54	38	
		R807606		3/4"		63	41	
		R807404	M30	1/2"		54	38	
		R807703	M28	3/8"	M22 x 1.5	48	21.5	16
		R807707 R807704B*		1/2"	M22 x 1.5	53	34	16
	Equerre coudé	R809604C R809604QC	M28	1/2"		85.5	53	44
	Equerre coudé	R809704C0	M28	1/2"	M22x1.5	77.5	53	44
	Thermo- triaxe	R806603	M28			46	23	
		R806604 R806604Q				53	23	
		R806606				62	28.5	
		R806404	M30			53	23	



ROBINET THERMOSTATIQUE KV FIXE FIXOSAR

COMAP







GAMME AU CATALOGUE

Photo	Figure Co.	Dim EN 215	Connexion Tête	Forme	Connexion tube	Connexion radiateur	Kv BP2K	Code
	R808	F	M28x1.5	Equerre	Rp 3/8	R 3/8	0.55	R808603
					Rp 1/2	R 1/2	0.55	R808604
					Rp 3/4	R 3/4	0.95	R808606
					Rp 3/8	O-ring R 3/8	0.55	R808603B
					Rp 1/2	O-ring R 1/2	0.55	R808604B
	R808E	F	M28x1.5	Equerre	Male M22	R 3/8	0.55	R808703
						R 1/2	0.55	R808704
						O-ring R 3/8	0.55	R808703B
						O-ring R 1/2	0.55	R808704B
	R809	F	M28x1.5	Droit	Rp 3/8	R 3/8	0.55	R809603
					Rp 1/2	R 1/2	0.55	R809604
					Rp 3/4	R 3/4	0.95	R809606
					Rp 1/2	O-ring R 1/2	0.55	R809604B
					Rp 1/2	R 1/2	0.95	R809604Q
	R809C	F	M28x1.5	Equerre coudé	Rp 1/2	Elbow R 1/2	0.55	R809604C
					Rp 1/2	Elbow R 1/2	0.95	R809604QC
	R809EC	F	M28x1.5	Equerre coudé	Male M22	Elbow R 1/2	0.55	R809704C
	R809E	F	M28x1.5	Droit	Male M22	R 1/2	0.55	R809704
						O-ring R 1/2	0.55	R809704B
	R807	F	M28x1.5	Thermotriaxe	Rp 3/8	R 3/8	0.55	R807603
					Rp 1/2	R 1/2	0.55	R807604
					Rp 3/4	R 3/4	0.55	R807606
					Rp 1/2	R 1/2	0.55	R807604Q
	R807E	F	M28x1.5	Equerre inverse	Male M22	R 3/8	0.55	R807703
					Male M22	R 1/2	0.55	R807704



ROBINET THERMOSTATIQUE KV FIXE FIXOSAR

COMAP

Photo	Figure Co.	Dim EN 215	Connexion Tête	Forme	Connexion tube	Connexion radiateur	Kv BP2K	Code
	R807EB	F	M28x1.5	Equerre inverse	Male M22	O-ring R 1/2	0.55	R807704B
	R806**	F	M28x1.5	Thermotriaxe	Rp 3/8	R 3/8	0.6	R806603
					Rp 1/2	R 1/2	0.6	R806604
					Rp 3/4	R 3/4	0.95	R806606
					Rp 1/2	R 1/2	0.95	R806604Q
	R804	DIN	M30	Equerre	Rp 3/8	R 3/8	0.55	R804403
					Rp 1/2	R 1/2	0.55	R804404
					Rp 3/4	R 3/4	0.95	R804406
	R805	DIN	M30	Droit	Rp 3/8	R 3/8	0.55	R805403
					Rp 1/2	R 1/2	0.55	R805404
					Rp 3/4	R 3/4	0.95	R805406
	R807	DIN	M30	Equerre inverse	Rp 1/2	R 1/2	0.55	R807404
	R806**	DIN	M30	Thermotriaxe	Rp 1/2	R 1/2	0.55	R806404

*La mention (D) ou (F) signifie que les dimensions hors-tout sont identiques aux dimensions mentionnées entre parenthèses dans la norme EN215, mais la norme EN215 n'inclut pas les filetages extérieurs.

** Produit non certifié



ROBINET THERMOSTATIQUE KV FIXE FIXOSAR

COMAP

INSTALLATION

Valve		M22	EUROCONE	
Pipe				
Cu				
PEX-PB				
MultiLayer				

RÉGLAGE DE LA POSITION NOMINALE



- Fermer le robinet complètement et marquer la position
- Ouvrir et compter 6 crans. Le robinet est ouvert à l'ouverture nominale.



ROBINET THERMOSTATIQUE KV FIXE FIXOSAR



COURBES HYDRAULIQUES 804-805-807-808-809 3/8"-1/2"

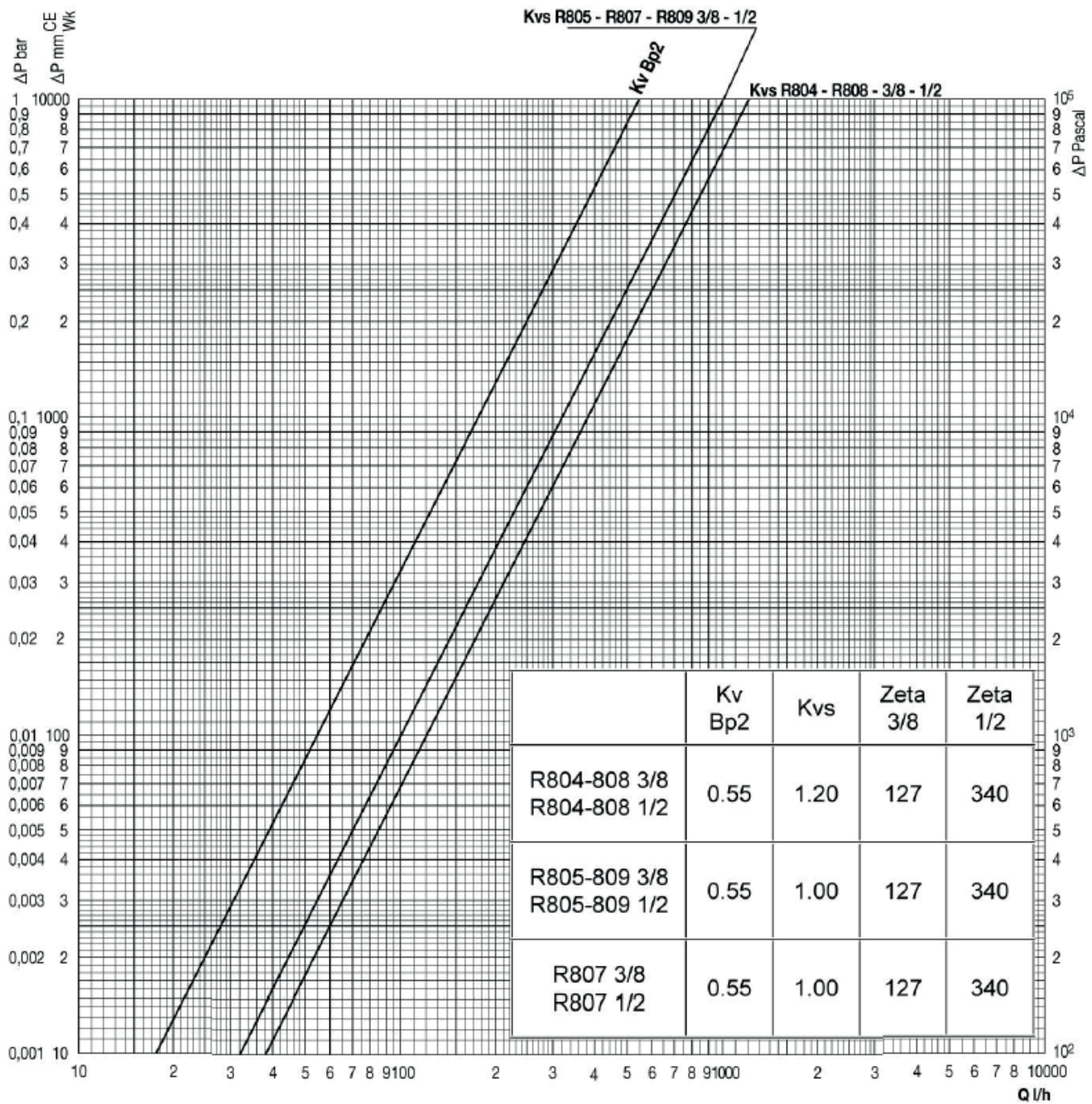



ROBINET THERMOSTATIQUE KV FIXE FIXOSAR

COMAP

804-805-808-809 3/4"

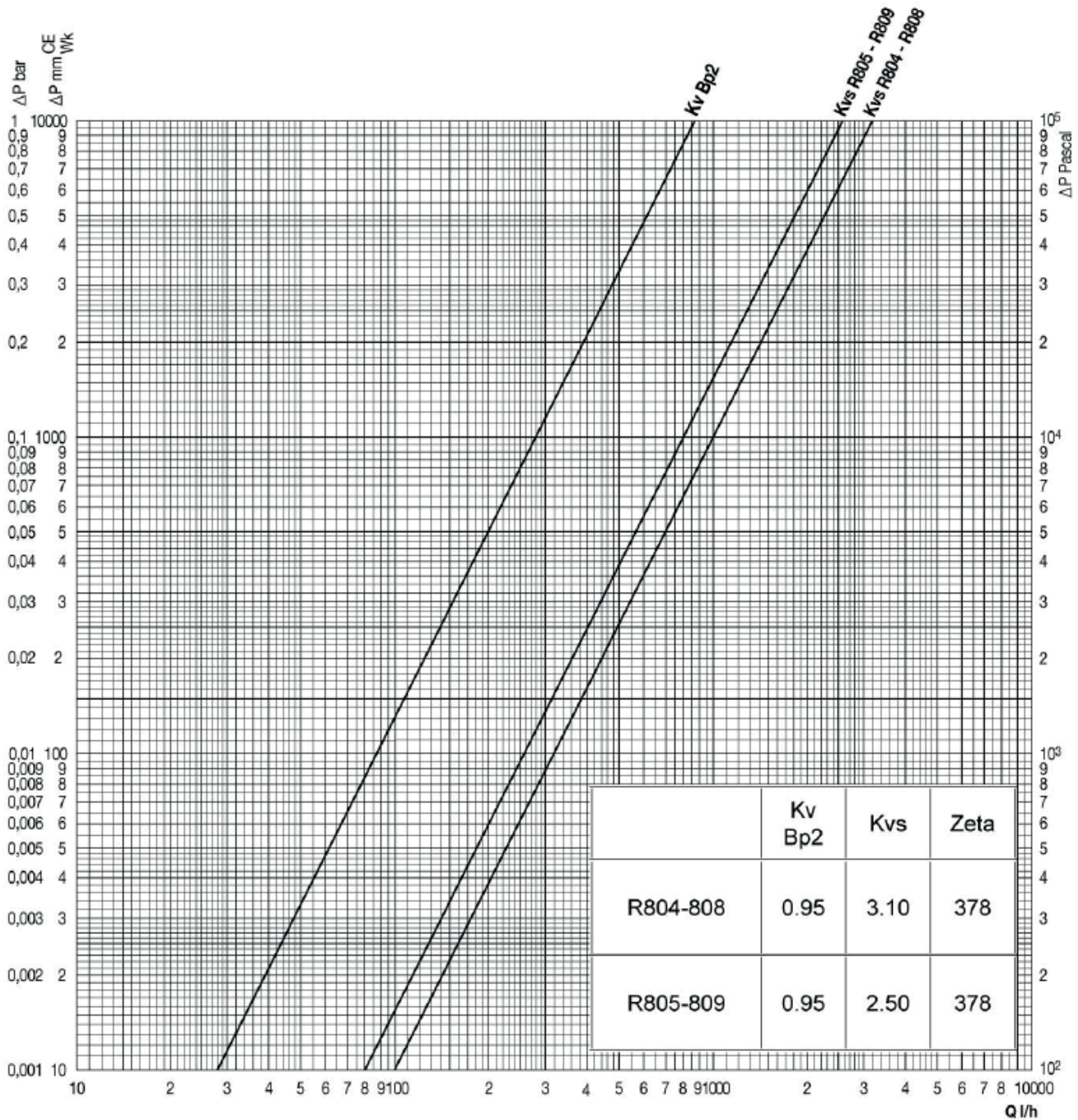



ROBINET THERMOSTATIQUE KV FIXE FIXOSAR

COMAP

ACCESSOIRES

Illustration	Ref	Désignation
	R815555	Cartouche M28 3/8, 1/2" Kv 0.55
	R815532	Cartouche M30 3/8, 1/2" Kv 0.55
	R816590	Cartouche M28 3/4" Kv 0.95