

# sarlam

## MINI CHARTRES

 [www.sarlam.com](http://www.sarlam.com)

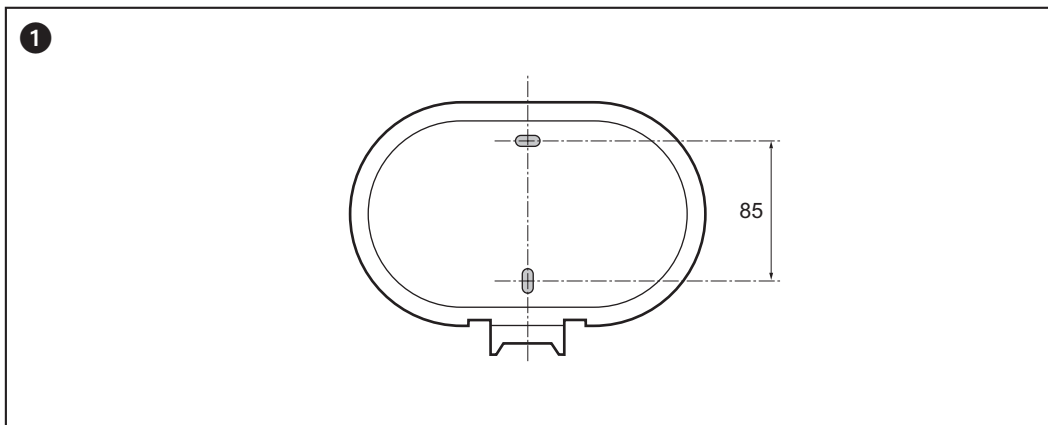
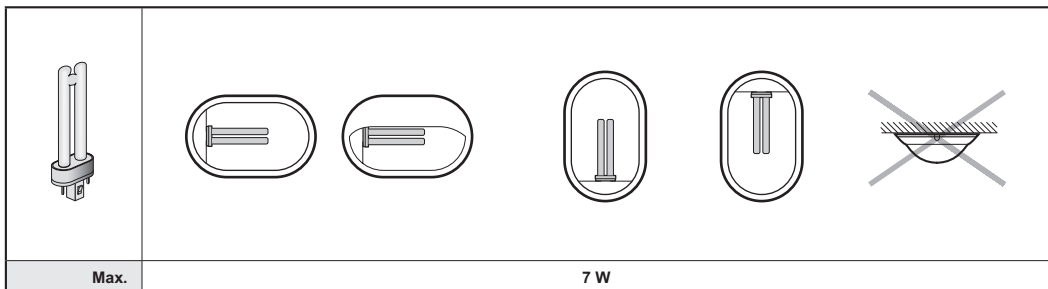
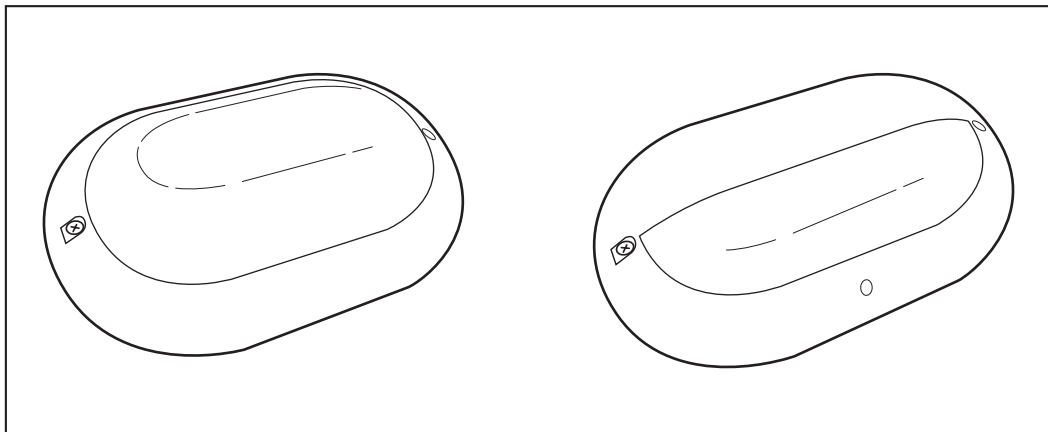

2

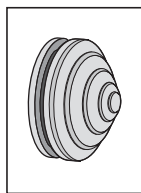

Ø 5 min.  
16 max.

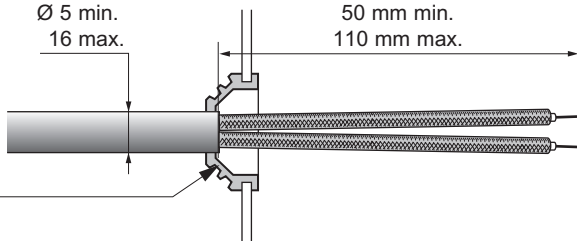

L N

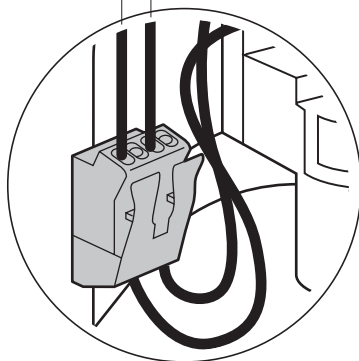

3

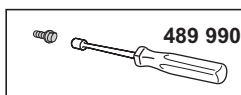
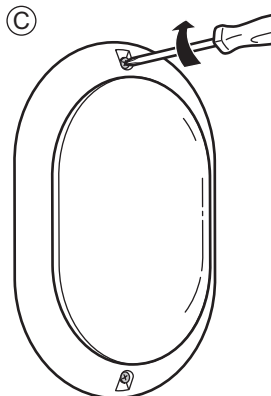
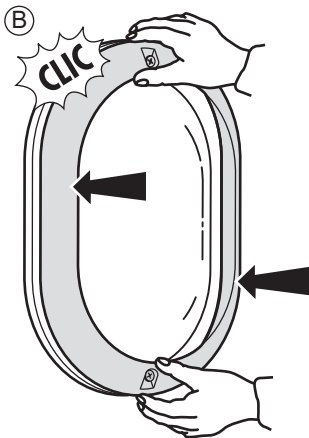
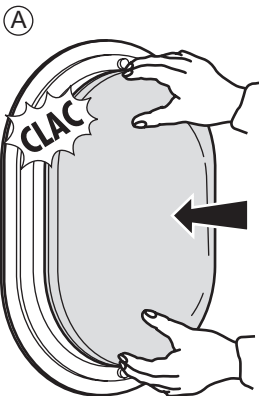

489 990