

WI3S/C | Haverland notice



Radiateur thermique auto-programmable - WI 3 - 450W - Horizontal - Blanc

Réf WI3S/C **269.81€^{TTC*}**

<https://www.domomat.com/29678-radiateur-thermique-auto-programmable-wi-3-450w-horizontal-blanc-haverland-wi3s-c.html>



Radiateur thermique auto-programmable - WI 5 - 800W - Horizontal - Blanc

Réf WI5S/C **317.62€^{TTC*}**

<https://www.domomat.com/29786-radiateur-thermique-auto-programmable-wi-5-800w-horizontal-blanc-haverland-wi5s-c.html>



Radiateur thermique auto-programmable - WI 7 - 1100W - Horizontal - Blanc

Réf WI7S/C **363.34€^{TTC*}**

<https://www.domomat.com/29787-radiateur-thermique-auto-programmable-wi-7-1100w-horizontal-blanc-haverland-wi7s-c.html>



Radiateur thermique auto-programmable - WI 9 - 1400W - Horizontal - Blanc

Réf WI9S/C **410.38€^{TTC*}**

<https://www.domomat.com/29788-radiateur-thermique-auto-programmable-wi-9-1400w-horizontal-blanc-haverland-wi9s-c.html>



Radiateur thermique auto-programmable - WI 11 - 1700W - Horizontal - Blanc

Réf WI11S/C **458.11€^{TTC*}**

<https://www.domomat.com/29790-radiateur-thermique-auto-programmable-wi-11-1700w-horizontal-blanc-haverland-wi11s-c.html>

*Retrouvez tous les produits de la catégorie
Tous les radiateurs Haverland
chez Domomat !*

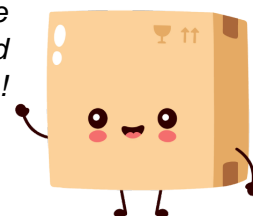

Manual de instalación y uso

Manual de instalação e uso

Notice d'installation et utilisation

Instructions and installation manual

Wi SmartWave



SMARTBOX



**NO SUMINISTRADA
NÃO INCLUIDA
NON FOURNI
NOT SUPPLIED**

Castellano

Português

Français

English



HAVERLAND

www.haverland.com



CASTELLANO:

ÍNDICE:

* ADVERTENCIAS GENERALES	4
1. Introducción	5
1.1 Descripción	5
1.2 Características	5
1.3 Panel mandos/Pantalla ...	5
2. Instalación	5
2.1 Normas Importantes	5
2.2 Medidas de seguridad	5
2.3 Pasos	6
3. Funcionamiento	7
3.1 Su emisor está configurado ..	7
3.2 Modos de funcionamiento ..	8
3.3 Ajuste de la temperatura ..	8
3.4 Temperaturas de Confort, Antihielo y Economía	9
3.5 Función “Ventanas Abiertas”	9
3.6 Función “Bloqueo de teclado	9
3.7 Standby	10
3.8 Ajuste del Día y la Hora ...	10
3.9 Otras indicaciones	10
3.9.1 Indicador Resistencia Encendida	10
3.9.2 Indicador Sensor Conectado	11
4. Batería	11
5. Mantenimiento	11
6. Smartbox (no suministrada).....	11
* Garantía	11

PORTUGUÊS:

CONTEÚDO:

* ADVERTÊNCIAS GERAIS	12
1. Introdução	13
1.1 Descrição	13
1.2 Características.....	13
1.3 Painel de comandos / Ecrã	13
2. Instalação	13
2.1 Normas Importantes	13
2.2 Medidas de segurança	13
2.3 Passos	14
3. Funcionamento	15
3.1 O emissor está configurado ..	15
3.2 Modos de funcionamento ..	16
3.3 Regulação de temperatura ..	16
3.4 Temperaturas de Conforto, Anti-gelo y Economia	17
3.5 Função “Janelas Abertas”	17
3.6 Função “Bloqueio de teclado	17
3.7 Standby	18
3.8 Regulação do Dia e da Hora	18
3.9 Outras indicações	18
3.9.1 Indicador Resistência Ligada	18
3.9.2 Indicador Sensor Ligado	19
4. Bateria	19
5. Manutenção	19
6. Smartbox (não incluído)	19

FRANÇAIS:**INDEX:**

* Avertissements généraux	20
1. Introduction	21
1.1 Description	21
1.2 Caractéristiques.....	21
1.3 Panneau de commandes..	21
2. Installation	21
2.1 Normes	21
2.2 Mesures de sécurité	21
2.3 Pas à suivre	22
3. Fonctionnement	23
3.1 Votre émetteur est configuré!	23
3.2 Modes de fonctionnement..	24
3.3 Ajustement de la temp.	24
3.4 Températures de Confort, Antigel et Économie	25
3.5 Fonction “Fenêtres Ouvertes”	25
3.6 Fonction “Blocage du clavier”	25
3.7 Standby	26
3.8 Ajustement Jour et l’Heure	26
3.9 Autres indications	26
3.9.1 Indicateur Résistance Allumée:	26
3.9.2 Indicateur Capteur connecté:	27
4. Batterie	27
5. Entretien	27
6. Smartbox (non fourni)	27

ENGLISH:**INDEX:**

* GENERAL WARNINGS	28
1. Introduction	29
1.1 Description	29
1.2 Characteristics	29
1.3 Panel Controls / Screen .	29
2. Installation	29
2.1 Regulations	29
2.2 Safety measures	29
2.3 Steps	30
3. Operation	31
3.1 Your heater is configured! .	31
3.2 Operating modes	32
3.3 Adjusting the temperature	32
3.4 Comfort, Anti-frost and Economy temperatures	33
3.5 “Open Window” Function	33
3.6 “Keypad Black” Function	33
3.7 Standby	34
3.8 Adjusting day and time ...	34
3.9 Other indications	34
3.9.1 Heating element on indicator	34
3.9.2 Sensor indicator on	35
4. Battery	35
5. Maintenance	35
6. Smartbox (not supplied)	35
* Guarantee	35



Advertencias generales

- Por favor, lea las instrucciones explicativas para su montaje.
- Para desconectar el emisor de la red eléctrica saque la clavija de alimentación del enchufe. Nunca tire del cable.
- No dejar el cable de conexión en contacto con el aparato mientras esté encendido.
- Durante su funcionamiento, debe tenerse la precaución de mantener el aparato alejado de materiales combustibles tales como cortinas, moquetas, muebles, etc.
- **NO CUBRIR EL APARATO. NO LO USE PARA SECAR ROPA.**



Si se cubre, existe el riesgo de producirse un sobrecalentamiento.



- **PELIGRO:** Si el cable de alimentación está dañado, debe ser sustituido por el fabricante o por su Servicio Postventa, por personal cualificado similar con el fin de evitar un peligro.
- Si el aparato se va a instalar en un cuarto de baño, debe ser colocado de tal manera que el aparato no pueda ser tocado por cualquier persona que se encuentre en la bañera o ducha.
- El aparato no debe estar situado debajo o delante de una toma de corriente.
- Cuando se desechen los emisores, deben tenerse en cuenta los requisitos establecidos por la legislación para el tratamiento y reciclaje de los residuos.
- La instalación debe ser efectuada según la legislación eléctrica vigente.
- Este aparato debe ser conectado a tierra.
- El emisor debe ser instalado de tal manera que la clavija de alimentación sea siempre accesible.
- Este emisor no se debe encastrar. Respetar siempre las distancias de seguridad.
- Para evitar que los niños puedan variar la programación del emisor, dispone de un bloqueo.
- Este aparato no está pensado para ser usado por personas (incluidos niños) con capacidades físicas reducidas, sensoriales o mentales, con poca experiencia o conocimiento, al menos que estén bajo supervisión de una persona responsable de su seguridad con las instrucciones de uso del aparato. Los niños deben ser supervisados para asegurar que no juegan con el aparato.
- Los niños menores de 3 años deben mantenerse fuera del alcance del aparato a menos que sean continuamente supervisados.
- Los niños desde 3 años y menores de 8 años deben sólo encender/apagar el aparato siempre que éste haya sido

CASTELLANO

colocado o instalado en su posición de funcionamiento normal prevista y que sean supervisados o hayan recibido instrucciones relativas al uso del aparato de una forma segura y entiendan los riesgos que el aparato tiene.

- Los niños desde 3 años y menores de 8 años no deben enchufar, regular y limpiar el aparato o realizar operaciones de mantenimiento.
- Este aparato puede ser usado por niños mayores de 8 años y por personas con discapacidades físicas, sensoriales o mentales, o sin experiencia o conocimientos, siempre y cuando hayan sido debidamente formados y son supervisados por alguien que entiende los riesgos.

La limpieza y el mantenimiento a realizar por el usuario no se deben hacer por niños. Los niños no deben jugar con el aparato.



- **PRECAUCIÓN:** Algunas partes de este producto pueden ponerse muy calientes y causar quemaduras. Debe ponerse atención particular cuando los niños y las personas vulnerables estén presentes.



- **PRECAUCIÓN:** Mantener las bolsas y demás accesorios que se incluyen fuera del alcance de los niños.

- Evite tocar las partes externas del emisor durante su funcionamiento.
- Es normal que en el primer arranque el aparato desprenda un olor “a nuevo”. Haga funcionar su emisor en un lugar ventilado durante 2 ó 3 horas.
- Antes de cada campaña de invierno o si el aparato ha estado desconectado durante varios días, limpie el aparato antes de conectarlo (siga los pasos “sección Mantenimiento”). Con dicha limpieza evitará “quemar el polvo acumulado y otros restos.
- El efecto de la convección, junto a otros factores ambientales, pueden causar decoloración en las superficies metálicas y en los plásticos.
- Los contrastes de temperatura pueden generar “chasquidos” o ruidos en el aparato. Esto no es un fallo del radiador.
- La garantía del aparato no cubrirá cualquier daño causado por la no lectura de estas instrucciones.

1 Introducción

1.1 Descripción

Los emisores Wi son una nueva gama de emisores térmicos que incorporan el termostato autoprogramable inteligente **i2Control**.

1.2 Características

• Termostato i2Control autoprogramable. No necesita que usted programe su emisor. **El aparato se autoprograma solo.**

• Gracias a su sensor de presencia y a sus algoritmos, monitorea continuamente sus hábitos de vida controlando en todo momento su consumo eléctrico, y sobre todo su confort.

• Detección de ventanas abiertas. Si usted se deja la ventana abierta, el aparato se desconecta para evitar desperdicio de energía.

• El teclado es táctil y sensible.

1.3 Panel mandos / Pantalla

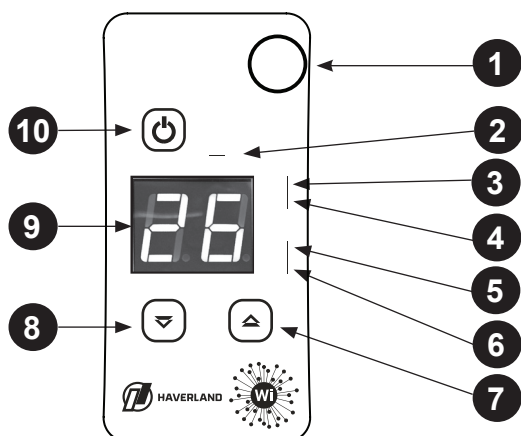

Descripción:

1. Sensor
2. Indicador de temperatura
 - Rojo = Confort
 - Azul = Anti-hielo
 - Verde = Economía
3. Indicador Modo de Funcionamiento:
 - Parpadeo = Modo "Aprendizaje"
 - Fijo = Modo Sensor
 - Apagado = Modo Manual o modo programación forzada (vía App con Smartbox, no suministrada)
4. Indicador Programación "forzada" vía App con Smartbox (no suministrada)
5. Indicador de Sensor
6. Resistencia encendida
7. Aumentar

8. Disminuir

9. Pantalla:

- Temperatura ambiente
- Temperatura seleccionada
- Reloj y día

10. Standby

2 Instalación

2.1 Normas Importantes:

• Es indispensable que el emisor **SE FIJE FIRMEMENTE A UNA PARED FIRME Y NIVELADA.**

• **Para optimizar la detección de presencia de su emisor, evite instalarlo en un ángulo "muerto" o detrás de un mueble.**

• El emisor nunca debe ser colocado justo por debajo de una toma de corriente.

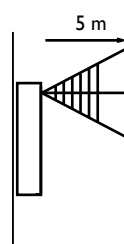
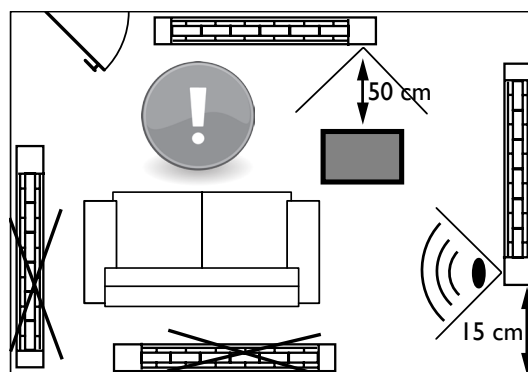

• Tenga en cuenta el lugar de emplazamiento del emisor, de tal manera que pueda detectar el mayor área posible de la estancia.

• El sensor de presencia no detecta movimiento si la distancia al emisor es mayor de 5 m.

• Tenga en cuenta que el sensor detecta movimientos de mascotas.

• **NO COLOQUE OBJETOS DELANTE NI CERCA DEL SENSOR.**

2.2 Medidas de seguridad:

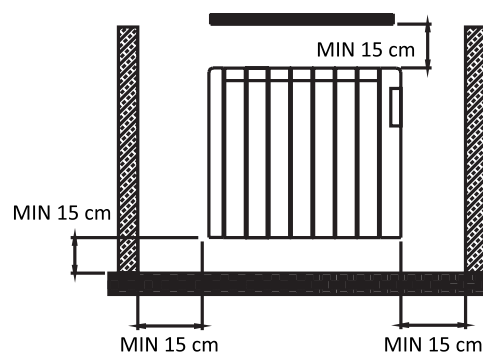

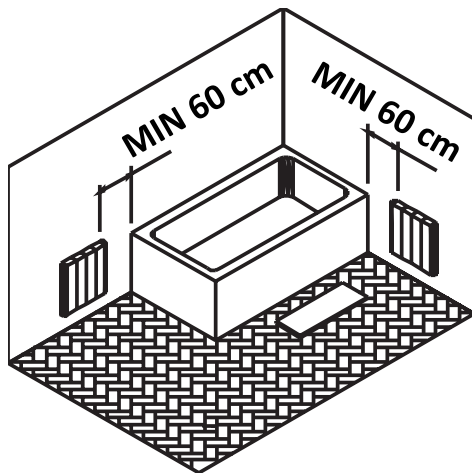

2.3 Pasos:

- 1) Es indispensable que el emisor SE FIJE FIRMEMENTE A UNA PARED FIRME Y NIVELADA.
- 2) Saque del interior de la caja de embalaje la plantilla donde se indica la posición de los taladros.
- 3) Comprobar que exista un enchufe cerca de donde lo vaya a situar.

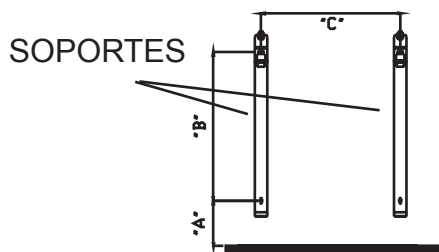
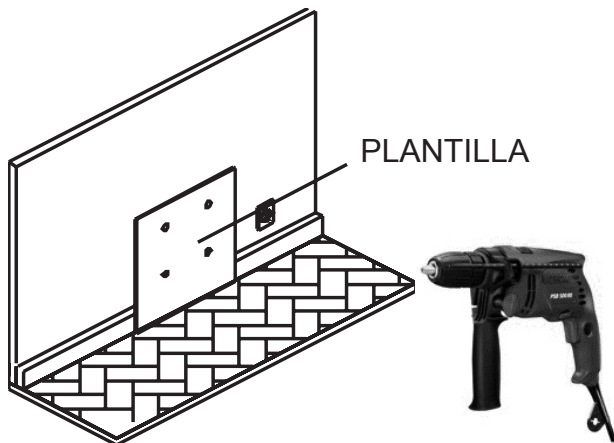

- 4) En los 4 taladros realizados, introducir los 4 tacos de diámetro 8 mm y fijar los dos soportes a la pared con los 4 tornillos 5,5 x 50 mm.

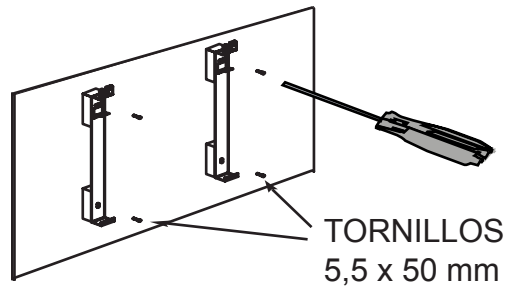

- 5) Atornillar en cada soporte, los dos tornillos de M. 6 x 40.

2 TORNILLOS
M. 6 x 40 mm

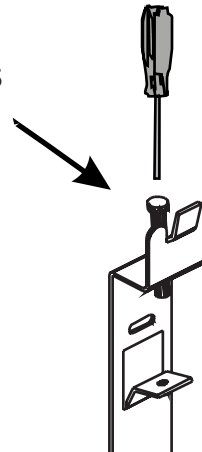

- 6) Posicione el emisor en la parte inferior de los soportes.

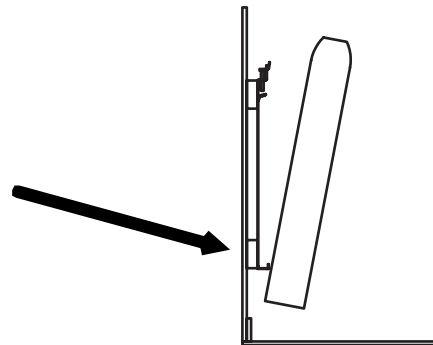

- 7) Fije el emisor en la parte superior de los soportes:

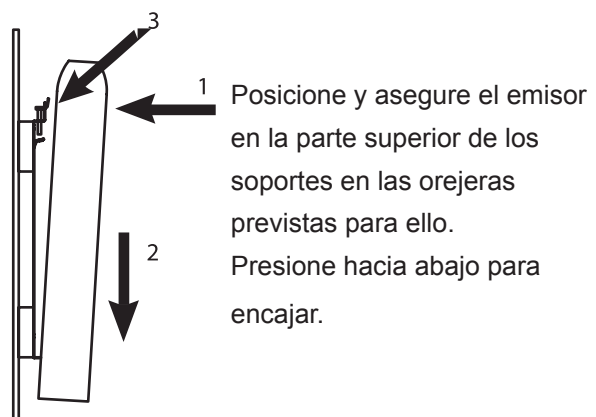

- 8) Atornille al fondo los 2 tornillos M. 6 x 40 mm para fijar el emisor a la pared.

3 Funcionamiento

3.1 Su emisor está configurado!

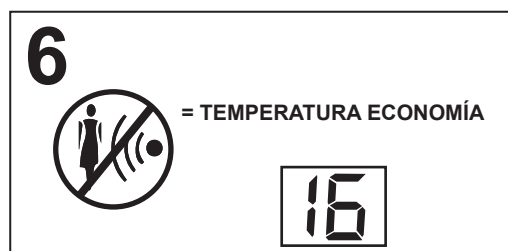
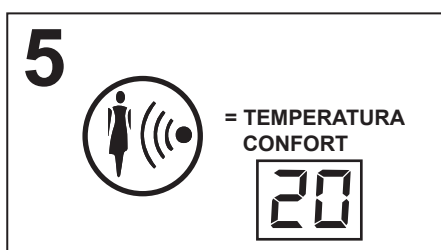
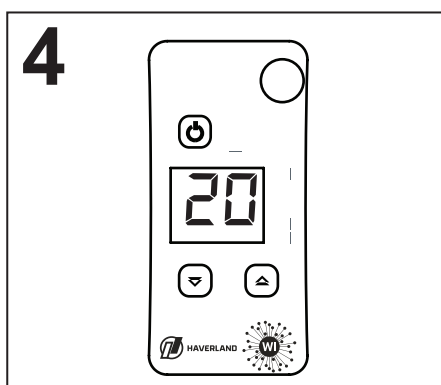
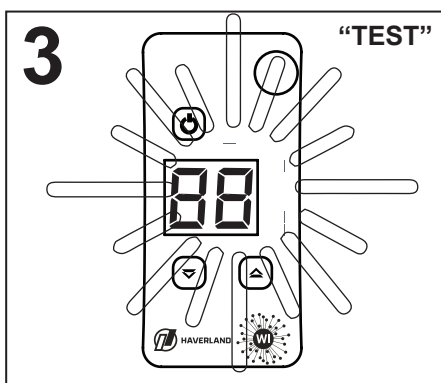
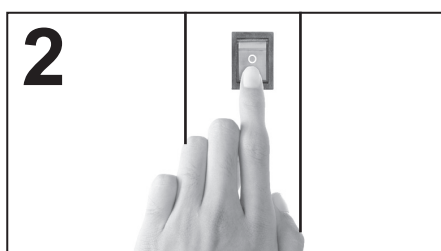
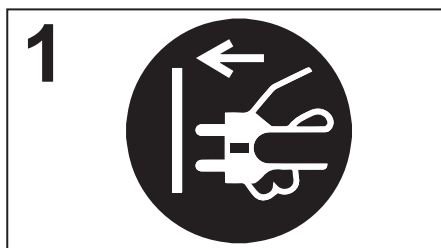

* Su emisor está listo para aprender sus hábitos de vida y para calentar SIN NECESIDAD DE PROGRAMAR NADA.

* Según nuestra presencia, aprenderá un patrón para cada día de la semana, semana a semana.

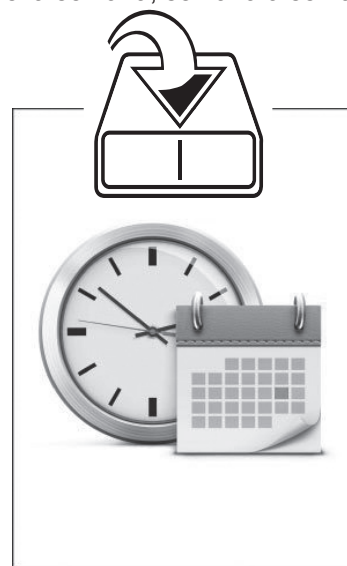

* El emisor NUNCA para de aprender. Si cambiamos nuestros hábitos de levantarnos, acostarnos, etc, el aparato se re programa para adaptarse a los nuevos hábitos.

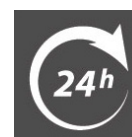

NOTA: Parámetros de serie:



- 1) Reloj y día actual programado de serie.
- 2) Temperatura de confort = 20 °C.
- 3) Temperatura de economía = 16 °C.
- 4) Modo de funcionamiento activado = Modo "aprendizaje".
- 5) Perfil activado de funcionamiento - Modo "aprendizaje" = Perfil económico "PE".

3.2 Modos de funcionamiento

Su emisor dispone de 4 modos de funcionamiento.

De fabrica, esta activado el modo "aprendizaje"

Para cambiar el modo de funcionamiento:

Pulse a la vez las teclas  y  cada vez que quiera cambiar de modo de funcionamiento.

El indicador luminoso 3 irá cambiando:

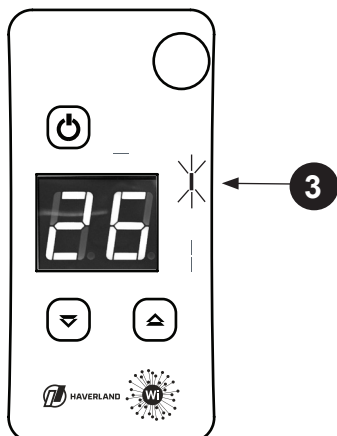

- 1) Modo "Aprendizaje": Luz "parpadeo suave".
- 2) Modo Manual: Luz OFF.
- 3) Modo Sensor: Luz fija.
- 4) Modo Programación "forzada". Consulte manual Smartbox (no suministrada).



1) MODO "APRENDIZAJE" (activado de fabrica):

Durante 7 días, y de FORMA CONTINUA, semana a semana, su emisor aprenderá su estilo de vida.

El emisor Wi dispone 2 perfiles de funcionamiento:



* Perfil Económico "PE" (activado de fabrica):

En este perfil prima el ahorro de energía.

- 1) Si hay detección:  **Modo Confort.**
- 2) Si NO hay detección  > 30 minutos = Modo Economía.
- 3) Si NO hay detección  > 12 horas = Modo Anti-hielo.

* Perfil Confort "PC":

En este perfil prima el confort y el bienestar.

- 1) Si hay detección:  **Modo Confort.**
- 2) Si NO hay detección  > 30 minutos = Modo Economía.
- 3) Si NO hay detección  > 16 horas = Modo Anti-hielo.



Día a día, el emisor Wi va "aprendiendo" los periodos de presencia (confort) y los periodos de ausencia (economía).

Después de 7 días, el aparato empezará a funcionar según los periodos de presencia (confort) y de ausencia (economía) programados, según el perfil de trabajo elegido.

Dependiendo del perfil elegido, los periodos de confort y de economía, a la semana siguiente, empezarán antes de la hora programada, para que usted tenga calefacción antes de que entre en la estancia.

Nota: El periodo de auto-programación es continuo. El emisor Wi se actualiza acorde a sus variaciones de su estilo de vida, día a día, semana a semana.

2) MODO SENSOR:

- 1) Si hay detección  = **Modo Confort**
- 2) Si NO hay detección > 30 minutos  = **Modo Economía.**



El termostato NO memoriza nada.

3) MODO MANUAL:

En este modo, usted elige cuando quiere estar en temperatura Confort, en temperatura Economía o en temperatura Anti-hielo.

Una vez elegido este modo Manual, solo basta elegir Confort, Anti-hielo o Economía y la temperatura ambiente deseada.

3.3 Ajuste de la temperatura

Para cambiar las temperaturas de confort y de economía, el emisor debe estar en MODO MANUAL (VER PUNTO 3.2).

El aparato de serie, las temperaturas son:

- 1) **TEMPERATURA CONFORT = 20 °C**
- 2) **TEMPERATURA ECONOMÍA = 16 °C**
- 3) **TEMPERATURA ANTI-HIELO = 5 °C**



La temperatura anti-hielo (5 °C) es invariable.

3.4 Temperaturas de Confort, Anti-hielo y Economía

El termostato tiene 3 temperaturas de pre-ajuste de temperatura.

La temperatura en funcionamiento se indica con colores en el indicador luminoso 2:

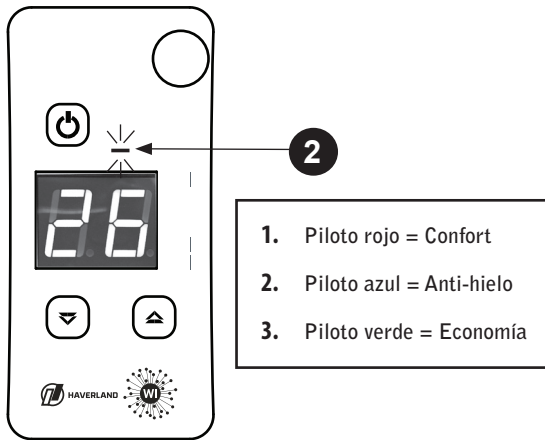

El ajuste por defecto de la temperatura de confort (cuando el ocupante está en la habitación) es de 20 °C.

El ajuste por defecto de la temperatura de economía (cuando el ocupante está ausente de la habitación o durmiendo) es de 16 °C.

El ajuste por defecto de la temperatura de anti-hielo (cuando el ocupante está ausente más de 12 horas de la habitación) es de 5 °C.

Para modificar la temperatura de confort o economía (la temperatura anti-hielo es fija):

1. Para cambiar las temperaturas de confort y de economía, el emisor debe estar en **MODO MANUAL** (VER PUNTO 3.2).
2. Elija la temperatura a cambiar, confort, anti-hielo o economía, pulsando la tecla

1. Piloto rojo = Confort
2. Piloto azul = Anti-hielo
3. Piloto verde = Economía

3. Pulse la tecla . Aparecerá parpadeando la temperatura ajustada durante unos segundos.

4. Pulse cualquiera de los botones y más de una vez para cambiar la temperatura ajustada.



Notas:

- El rango de la temperatura de confort es de 18 a 28 °C.
- El valor máximo de la temperatura de economía es de 18 °C.
- La temperatura de economía NUNCA puede ser superior a la temperatura de confort.
- La temperatura de economía puede ser entre 4 °C y 8 °C menos que la temperatura de confort asignada (Recuerde: el valor máximo de la temperatura de economía es 18 °C).

3.5 Función “Ventanas Abiertas”

El emisor dispone de esta función **automática, disponible únicamente en modo sensor (ver punto 3.2).**

Si en la estancia donde está situado el emisor, se produce una caída brusca de la temperatura ambiental, el emisor pasará a temperatura “Anti-hielo” (5 °C).

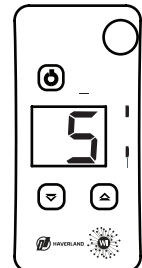
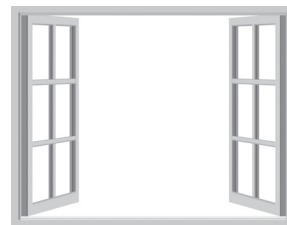

El aparato volverá a funcionar automáticamente cuando alguien entre de nuevo en la estancia.



Esta función no se puede desactivar.

3.6 Función “Bloqueo de teclado”

Para bloquear y desbloquear el teclado, pulse a la vez las teclas y .

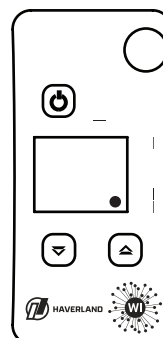

NOTA:

Tanto la pantalla como todos los indicadores luminosos se apagarán.

Aparece un punto luminoso en el lado derecho de la pantalla.

3.7 Standby

Para encender y apagar el emisor pulse .

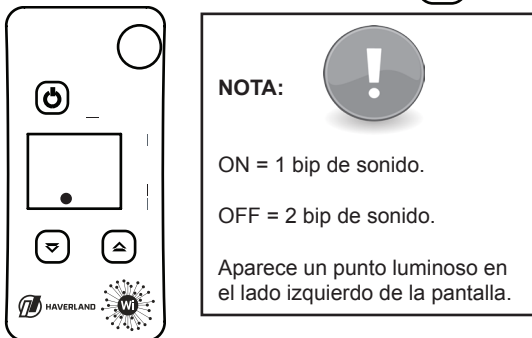

3.8 Ajuste del Día y la Hora

Su emisor viene ajustado de fabrica con el reloj y el día de la semana.

En los cambios de horarios de verano y de invierno, usted deberá ajustar el reloj del aparato (este ajuste es automático si dispone de Smartbox).

1. Pulse el botón  y el botón .

El símbolo “d” aparece en la pantalla.



Esperé.

A continuación, un número de 1 a 7 parpadea indicando el día de la semana.



Esperé. Ajuste el día de la semana pulsando

 o . Esperé.

2. El símbolo “h” aparece.



Esperé.

A continuación, el valor visualizado para las horas parpadea.



Ajuste la hora mediante  y . Esperé.



3. A continuación el símbolo “n” aparece en la pantalla.



Esperé.

A continuación, el valor visualizado para los minutos parpadea.



Ajuste los minutos mediante  o .

Esperé.

4. Seguidamente, le aparece el perfil de funcionamiento en modo aprendizaje “PE”, “Perfil Económico”.

En el perfil PE “Económico” se prima el ahorro de energía, mientras que en el perfil “PC”, “Perfil Confort” prima el bienestar.



Ajuste el perfil mediante  o .

Esperé.

A continuación, para finalizar aparece la temperatura aproximada de la habitación.

3.9 Otras indicaciones

3.9.1 Indicador Resistencia Encendida:

Cuando el emisor está calentando, el indicador luminoso 6 estará encendido.

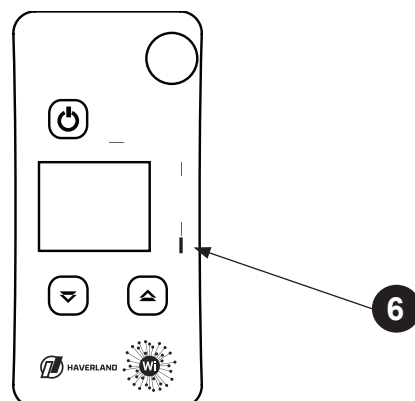

3.9.2 Indicador Sensor conectado:

Cuando el sensor está detectando, el indicador luminoso 5 estará encendido.

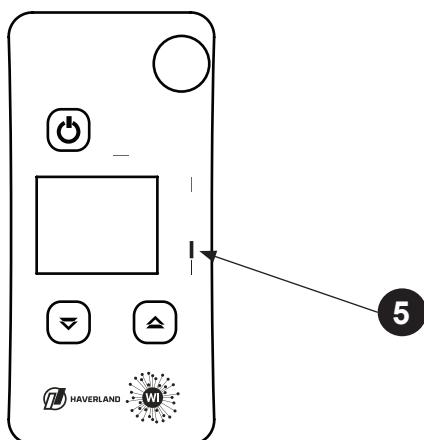

4. Batería

Su emisor está equipado con una batería de litio de larga duración.

Tras cambiar la batería, deberá ajustar el día y la hora (ver el punto 3.7) (este ajuste es automático si dispone de Smartbox).

5. Mantenimiento

Su emisor térmico no precisa de ningún tipo de mantenimiento especial.

Solamente limpie el polvo que se pueda acumular con un trapo seco y suave.

Es conveniente al comenzar la temporada de calefacción, limpiar el polvo acumulado sobre la superficie del emisor.



NUNCA UTILICE DISOLVENTES NI PRODUCTOS ABRASIVOS.

6. Smartbox (no suministrada)

Esté donde esté, controle a distancia todas las funciones de su emisor.

Programe su emisor desde la aplicación App Haverland.

Control 3G Wifi en la palma de su mano con nuestra smartbox (no suministrada)

Consulte con su distribuidor o a través de i2control@haverland.com.

* GARANTÍA

MARSAN INDUSTRIAL, S.A. garantiza la conformidad de los aparatos con las especificaciones del contrato.

Esta garantía cubre la reparación del aparato y comprenderá los gastos necesarios realizados para subsanar la falta de conformidad de los bienes con el contrato.

Dicha subsanación será garantizada durante un **plazo de 24 meses** desde la fecha de compra conforme a la factura contra cualquier defecto de fabricación y funcionamiento durante el uso normal y doméstico de éste producto.

El coste del material (piezas y recambios) será garantizado durante un plazo de **36 meses** y por **10 años** la estanqueidad del cuerpo de aluminio desde la fecha de compra conforme a la factura. Esta garantía ampara únicamente el aparato cuyo modelo esté anotado en la factura de compra.

Esta garantía **NO CUBRE** la instalación inadecuada, el mantenimiento, limpieza o conservación del aparato, así como tampoco las averías motivadas por fuerza mayor, agentes químicos o fenómenos atmosféricos, por uso indebido del aparato, por una instalación eléctrica del comprador defectuosa, transporte del aparato, ni por la manipulación del aparato por personal no autorizado por MARSAN INDUSTRIAL, S.A.

Esta garantía no tendrá ninguna validez si no está debidamente cumplimentada, fechada y sellada por el establecimiento autorizado del vendedor.

Esta garantía no debe ser modificada, alterada ni extendida, y el Fabricante no autoriza a nadie a actuar en su nombre en la modificación, alteración o extensión de ésta.

Esta garantía se aplica al Producto solamente. Para la reparación del aparato, el consumidor deberá dirigirse al Servicio de Asistencia Técnica al teléfono **91 324 40 60** (Horario: Lunes a Viernes de 9 a 20 h) o enviar un correo electrónico a info@haverland.com solicitando la información necesaria sobre el procedimiento a seguir.

Para la sustitución, cancelación o rebaja del precio, en su caso, el consumidor deberá dirigirse al establecimiento vendedor. Esta garantía no afecta a los derechos de que dispone el consumidor conforme a las previsiones dispuestas en la Ley 23/2003, de Garantía en la Venta de Bienes de Consumo.



Advertências gerais

PORTUGUÊS

- Leia as instruções de montagem.
- Para desligar o emissor térmico da rede eléctrica, retire a ficha de alimentação da tomada. Nunca puxe o cabo.
- Não deixe o cabo de ligação em contacto com o aparelho enquanto este estiver ligado.
- Durante o funcionamento, deve ter o cuidado de manter o aparelho afastado de materiais combustíveis como cortinas, alcatifas, móveis, etc.
- **NÃO CUBRA O APARELHO. NÃO O USE PARA SECAR ROUPA.**





Se for coberto, existe um risco de sobreaquecimento.

-  **PERIGO:** Se o cabo de alimentação estiver danificado, deve ser substituído pelo fabricante, pelo Serviço de Pós-venda ou por pessoal qualificado similar para evitar riscos.
- Num quarto de banho, o aparelho deve ser instalado de forma a não poder ser tocado por qualquer pessoa que se encontre na banheira ou duche.
- O aparelho não deve estar situado sob ou diante de uma tomada de corrente.
- Quando eliminar o emissor, deve ter em conta os requisitos definidos na legislação para o tratamento e reciclagem de resíduos.
- A instalação deve ser efectuada de acordo com a legislação eléctrica em vigor.
- Este aparelho deve estar ligado à terra.
- O emissor deve ser instalado de forma que a ficha de alimentação esteja sempre acessível.
- Este emissor não deve ser encastrado. Respeite sempre as distâncias de segurança.
- O emissor dispõe de um bloqueio para evitar que as crianças alterem a programação.
- Este aparelho não deve ser utilizado por pessoas (incluindo crianças) com capacidades físicas, sensoriais ou mentais diminuídas ou com pouca experiência ou conhecimento, excepto sob a supervisão de uma pessoa responsável pela sua segurança com as instruções de utilização do aparelho. As crianças devem ser vigiadas para garantir que não brincam com o aparelho.
- As crianças com menos de três anos devem ser mantidas fora do alcance do aparelho, excepto se estiverem sob supervisão constante.
- As crianças dos três aos oito anos devem somente ligar/desligar o aparelho desde que este tenha

sido colocado ou instalado na posição prevista de funcionamento normal e desde que estejam sob supervisão ou tenham recebido instruções relativas a uma utilização segura e compreendam os riscos do aparelho.

- As crianças dos três aos oito anos não devem ligar à corrente eléctrica, regular e limpar o aparelho ou realizar operações de manutenção.
- Este aparelho pode ser utilizado por crianças com mais de oito anos e por pessoas com incapacidades físicas, sensoriais ou mentais ou sem experiência ou conhecimentos, desde que tenham sido devidamente formados e sob supervisão de alguém que compreenda os riscos.

A limpeza e a manutenção a realizar pelo utilizador não devem ser feitas por crianças. As crianças não devem brincar com o aparelho.

-  **PRECAUÇÃO:** Algumas peças deste produto podem ficar muito quentes e causar queimaduras. Deve prestar especial atenção na presença de crianças e de pessoas vulneráveis.
-  **PRECAUÇÃO:** Mantenha os sacos e os restantes acessórios incluídos fora do alcance das crianças.
- Evite tocar nas partes exteriores do emissor durante o funcionamento.
- É normal que na primeira colocação em funcionamento o aparelho liberte um cheiro “a novo”. Deixe o emissor funcionar num local ventilado durante duas ou três horas.
- Antes de cada inverno ou depois de vários dias de inactividade, limpe o aparelho antes de o ligar (siga os passos da secção Manutenção). Com esta limpeza evitará queimar o pó acumulado e outros resíduos.
- O efeito da convecção, juntamente com outros factores ambientais, pode causar descoloração nas superfícies metálicas e nos plásticos.
- As variações de temperatura podem gerar “estalidos” ou ruídos no aparelho. Isto não constitui uma anomalia.
- A garantia do aparelho não cobre qualquer dano causado pela falta de leitura destas instruções.

1 Introdução

1.1 Descrição

Os Wi são uma nova gama de emissores térmicos que integram o termóstato inteligente **i2Control**.

1.2 Características

- Termóstato i2Control auto-programável. Não precisa que você programe o emissor. **O aparelho programa-se automaticamente sozinho.**
- Graças ao sensor de presença e aos algoritmos, monitoriza continuamente os seus hábitos, controlando permanentemente o consumo eléctrico e principalmente o conforto.
- Apresenta três modos de funcionamento: modo “aprendizagem”, modo sensor e modo manual.
- Detecção de janelas abertas. Se deixar a janela aberta, o aparelho desliga-se para evitar desperdício de energia.
- O teclado é táctil e sensível.

1.3 Painel de comandos / Ecrã

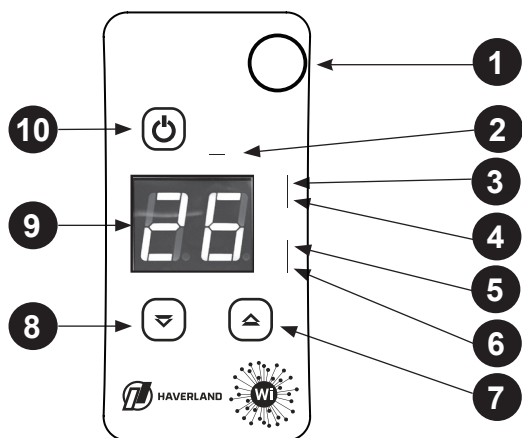

Descrição:

1. Sensor
2. Indicador de temperatura
 - Vermelho = Conforto
 - Azul = Anti-gelo
 - Verde = Economia
3. Indicador Modo de Funcionamento:
 - Intermitente = Modo “Aprendizagem”
 - Fixo = Modo Sensor
 - Apagado = Modo Manual ou modo programação forçada via App.
4. Indicador Modo Programação forçada via App.
5. Indicador de Sensor
6. Aquecimento ligado

7. Aumentar
8. Diminuir
9. Ecrã:
 - Temperatura ambiente
 - Temperatura seleccionada
 - Relógio e dia
9. Standby

2 Instalação

2.1 Normas:

- É indispensável **FIXAR O EMISSOR FIRMEMENTE A UMA PAREDE SÓLIDA E NIVELADA.**
- **Para otimizar a detecção de presença do emissor, evite instalá-lo num ângulo “morto” ou atrás de um móvel.**
- O emissor nunca deve estar colocado sob uma tomada de corrente eléctrica.

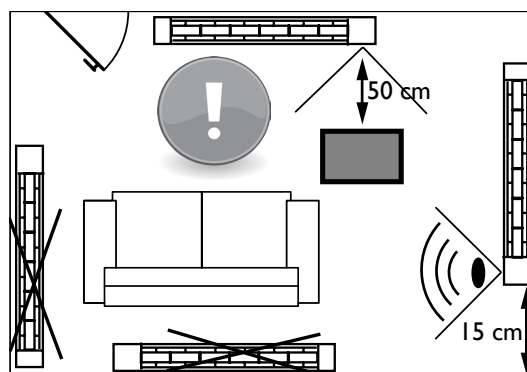

- **Tenha em conta o local de montagem do emissor, de forma que consiga detectar a maior área possível da divisão.**
- O sensor de presença não detecta movimento se a distância para o emissor for superior a 5 m.
- Tenha em conta que o sensor detecta movimentos de animais domésticos.
- **NÃO COLOQUE OBJECTOS DIANTE NEM PRÓXIMO DO SENSOR.**

2.2 Medidas de segurança:

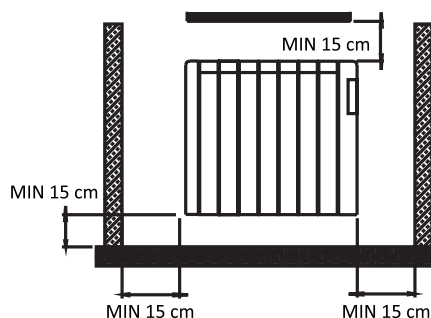

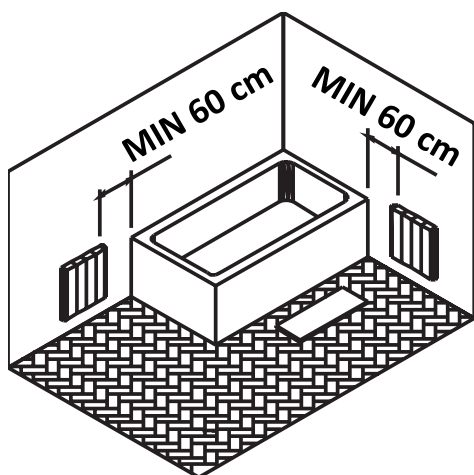

2.3 Passos:

- 1) É indispensável FIXAR O EMISSOR FIRMEMENTE A UMA PAREDE SÓLIDA E NIVELADA.
- 2) Retire do interior da caixa de embalagem o molde que indica a posição dos furos.
- 3) Certifique-se de que existe uma tomada próximo do local de instalação.

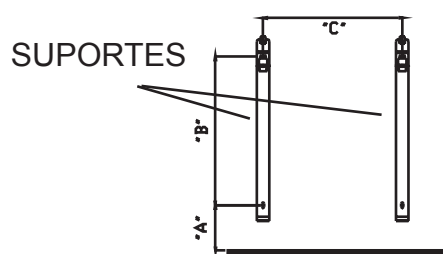
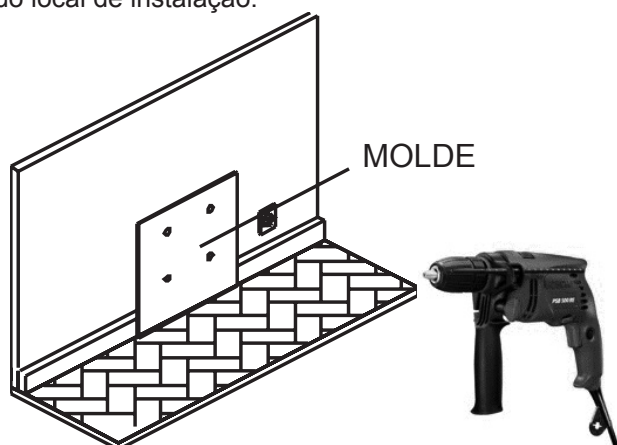

- 4) Nos quatro furos realizados, introduza as quatro buchas de diâmetro 8 mm e fixe os dois suportes à parede com os quatro parafusos 5,5 mm x 50 mm, com los 4 parafusos 5,5 x 50 mm.

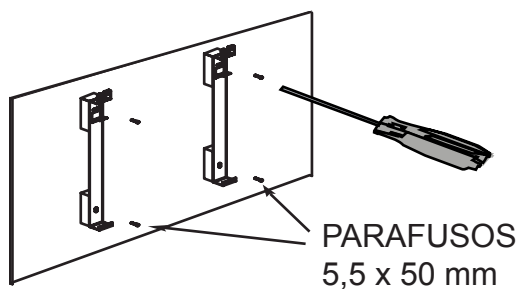

- 5) Aparafusar em cada suporte, os dois parafusos de M6 x 40.

2 PARAFUSOS
M. 6 x 40 mm

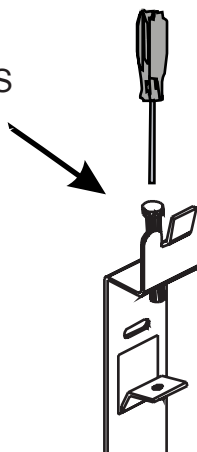

- 6) Posicione o emissor na parte inferior dos suportes.

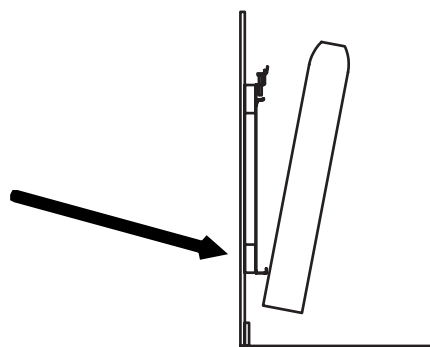

- 7) Fixe o emissor na parte inferior dos suportes.

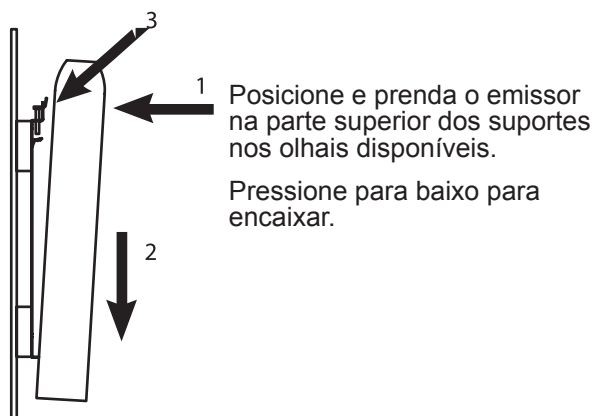

- 8) Aperte ao fundo os dois parafusos M6 x 40 mm para fixar o emissor à parede.

3 Funcionamento

3.1 O emissor está configurado!

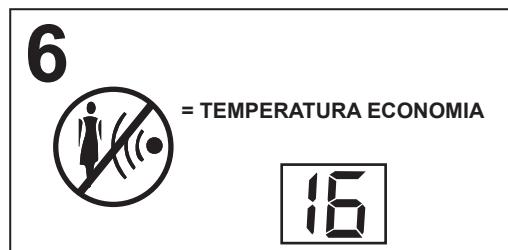
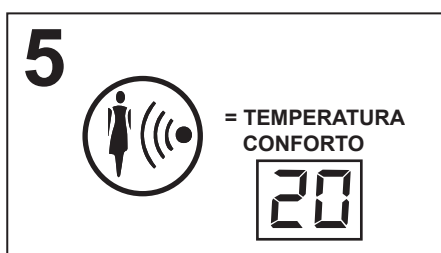
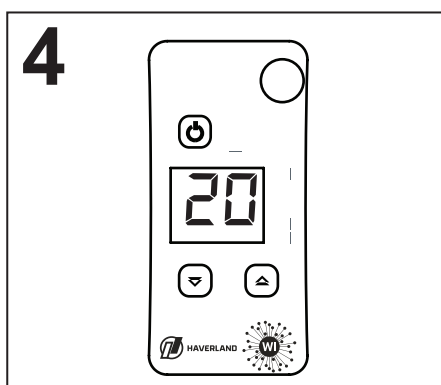
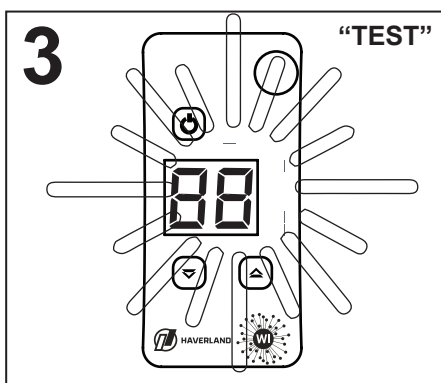
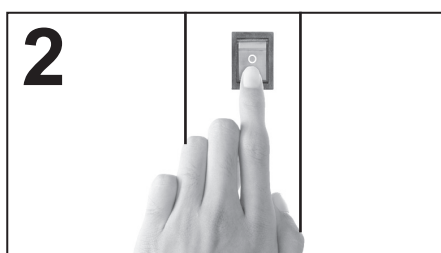
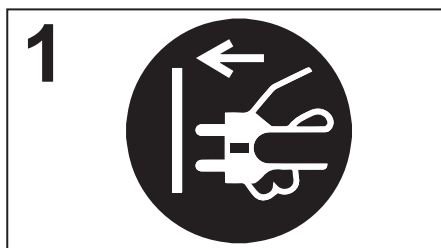

* O emissor está preparado para aprender os seus hábitos de vida e para aquecer SEM QUALQUER NECESSIDADE DE PROGRAMAÇÃO.

* De acordo com a sua presença, aprenderá um padrão para cada dia da semana, semana a semana.

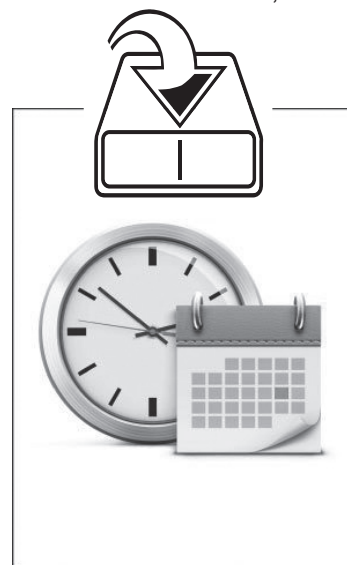

* O emissor NUNCA para de aprender. Se alterar a hora a que se deita ou levanta, etc., o aparelho reprograma-se para se adaptar aos novos hábitos.

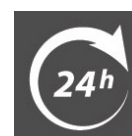



NOTA: Parâmetros de série:

- 1) Relógio e dia actual programado de série.
- 2) Temperatura de conforto = 20 °C
- 3) Temperatura de economia = 16 °C
- 4) Modo de funcionamento activado = Modo Aprendizagem.
- 5) Habilitado perfil operacional - Mode "aprendizagem" = Perfil Económico "PE".

3.2 Modos de funcionamento

O emissor dispõe de 4 modos de funcionamento. De fábrica, está activado o modo Aprendizagem. Para mudar o modo de funcionamento:

Carregue ao mesmo tempo nas teclas  e  quando quiser o modo de funcionamento.

O indicador luminoso 3 vai mudando:

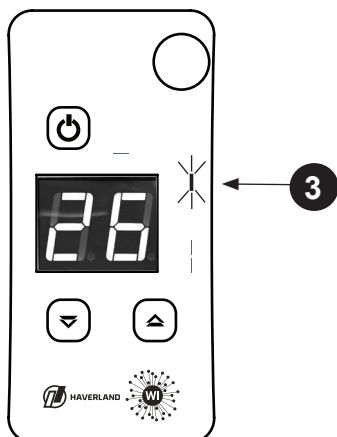

- 1) Modo Aprendizagem: Luz "intermitência ligeira".
- 2) Modo Manual: Luz OFF.
- 3) Modo Sensor: Luz fixa.
- 4) Modo Programação forçada via App. Consulte e manual Smartbox).



1) MODO "APRENDIZAGEM" (activado de fábrica):

Durante sete dias, e de FORMA CONTÍNUA, semana a semana, o emissor vai aprender o seu estilo de vida.

E emissor Wi dispõe de 2 perfis de funcionamento:



* Perfil Económico "PE" (activado de fábrica):

Neste perfil prima a poupança de energia:

- 1) Se houver deteção:  **Modo Conforto.**
- 2) Se NÃO houver deteção > 30 minutos = **Modo Economia.** 
- 3) Se NÃO houver deteção > 12 horas = **Modo Anti-gelo.** 

* Perfil Conforto "PC":

Neste perfil prima o conforto e o bem-estar:

- 1) Se houver deteção:  **Modo Conforto.**
- 2) Se NÃO houver deteção > 30 minutos = **Modo Economia.** 
- 3) Se NÃO houver deteção > 16 horas = **Modo Anti-gelo.** 



Dia a dia, o Wi vai "aprendendo" os períodos de presença (conforto) e os períodos de ausência (economia).

Passados sete dias, o aparelho começa a funcionar de acordo com os períodos de presença (conforto) e de ausência (economia) programados, de acordo com o perfil de trabalho seleccionado.

Os períodos de conforto, na semana seguinte, vão começar antes da hora programada, para aquecer a divisão antes de entrar.

Nota: O período de auto-programação é contínuo. O Wi é actualizado de acordo com as variações do seu estilo de vida, dia a dia, semana a semana.

2) MODO SENSOR:

- 1) Se houver deteção:  **Modo Conforto**
- 2) Se NÃO houver deteção > 30 minutos = **Modo Economia.** 



O termóstato NÃO memoriza nada.

3) MODO MANUAL:

Neste modo, você escolhe quando quiser a temperatura Conforto, a temperatura Economia ou a temperatura Anti-gelo.

Depois de escolher este modo Manual, só tem de escolher Conforto, Anti-gelo ou Economia e a temperatura ambiente pretendida.

3.3 Regulação da temperatura

Para mudar as temperaturas de conforto e de economia, o emissor deve estar no MODO MANUAL (VER PONTO 3.2).

No aparelho de série, as temperaturas programadas são:

- 1) TEMPERATURA CONFORTO = 20 °C
- 2) TEMPERATURA ECONOMIA = 16 °C
- 3) TEMPERATURA ANTI-GELO = 5 °C



A temperatura anti-gelo (5 °C) não pode ser alterada.

3.4 Temperaturas de Conforto, Anti-gelo e Economia

O termóstato tem três temperaturas de pré-regulação de temperatura.

A temperatura em funcionamento é indicada com cores no indicador luminoso 2:

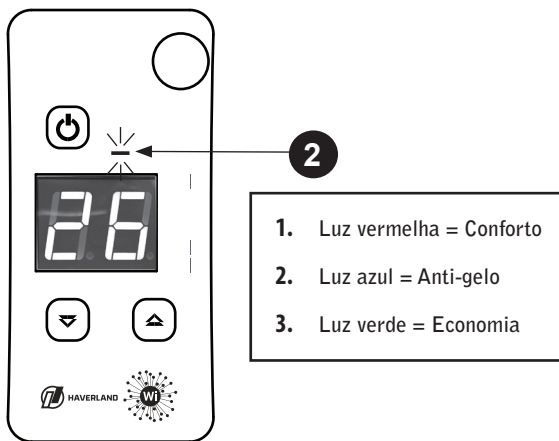

A regulação por defeito da temperatura de conforto (quando o ocupante estiver na divisão) é 20 °C.

A regulação por defeito da temperatura de economia (quando o ocupante não estiver na divisão ou estiver a dormir) é 16 °C.

A regulação por defeito da temperatura de antigelo (quando o ocupante não estiver na divisão durante mais de 12 horas) é 5 °C.



Para modificar a temperatura de conforto ou economia (a temperatura anti-gelo é fixa):

1. Para mudar as temperaturas de conforto e de economia, o emissor deve estar no **MODO MANUAL** (VER PONTO 3.2).

2. Escolha a temperatura a mudar, conforto, anti-gelo ou economia, carregando na tecla .

- | | |
|----|-------------------------|
| 1. | Luz vermelha = Conforto |
| 2. | Luz azul = Anti-gelo |
| 3. | Luz verde = Economia |

3. Carregue na tecla . Aparece a piscar a temperatura regulada durante alguns segundos.

4. Carregue em qualquer dos botões  e  mais de uma vez para mudar a temperatura regulada.

Notas:

- O intervalo da temperatura de conforto varia de 18 °C a 28 °C.
- O valor máximo da temperatura de economia é 18 °C.
- A temperatura de economia NUNCA pode ser superior à temperatura de conforto.
- A temperatura de Economia pode ser entre 4°C e 8°C menos que a temperatura de conforto definida.

3.5 Função “Janelas Abertas”

O emissor dispõe desta **função automática**. O modo janelas abertas só funciona no modo “sensor”.

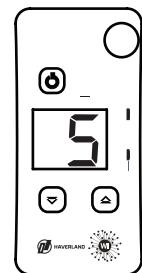
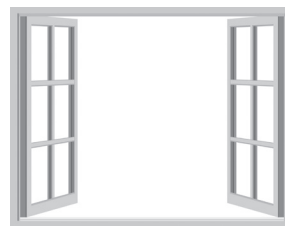

Se na divisão do emissor ocorrer uma queda da temperatura ambiente forte, o emissor passa para o modo Anti-gelo (5 °C).





O aparelho volta a funcionar automaticamente quando alguém entrar novamente na divisão.

 Esta função não pode ser desactivada.

3.6 Função “Bloqueio de teclado”

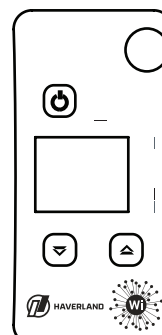
Para bloquear e desbloquear o teclado, carregue simultaneamente nas teclas  e .



<p>NOTA: </p> <p>Tanto o ecrã como todos os indicadores luminosos são desligados.</p> <p>Aparece um ponto luminoso no lado direito do ecrã.</p>

3.7 Standby

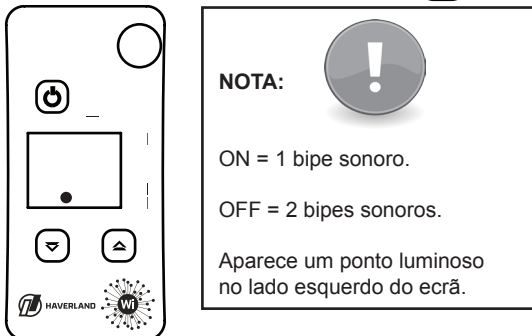

Para ligar e desligar o emissor carregue .



3.8 Regulação do Dia e da Hora

O emissor vem regulado de fábrica com o relógio e o dia da semana.

Nas mudanças de horários de verão e de inverno, deve acertar o relógio do aparelho (o ajuste da hora é automático se tem uma Smartbox).

1. Carregue no botão  e no botão .



O símbolo “d” aparece no ecrã



Aguarde.

Depois pisca um número de 1 a 7 que indica o dia da semana.



Aguarde. Regule o dia da semana carregando em  o . Aguarde.

2. Aparece o símbolo “h”.



Aguarde.

A seguir, o valor visualizado para as horas fica intermitente.



Regule a hora com  e . Aguarde.



3. A seguir o símbolo “n” aparece no ecrã.



Aguarde.

A seguir, o valor visualizado para os minutos fica intermitente.



Acerte os minutos com  ou .

Aguarde.

4. Seguidamente aparece e perfil de trabalho “PE” Perfil Económico.

Neste perfil prima a poupança de energia, mi entras que Perfil Conforto “PC” prima o conforto e o bem-estar.



Acerte o perfil com  ou .

Aguarde.

A seguir, para concluir aparece a temperatura aproximada da divisão.

3.9 Outras indicações

3.9.1 Indicador Resistência Ligada:

Quando o emissor estiver a aquecer, o indicador luminoso 6 vai estar ligado.

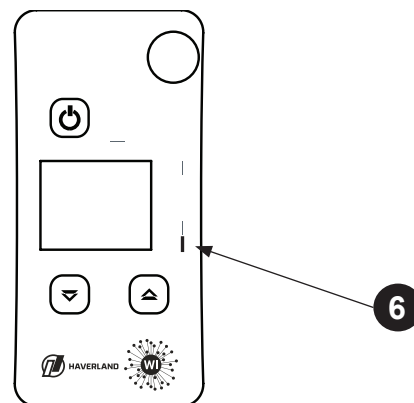

3.9.2 Indicador Sensor ligado:

Quando o sensor estiver a detectar, o indicador luminoso 5 fica aceso.

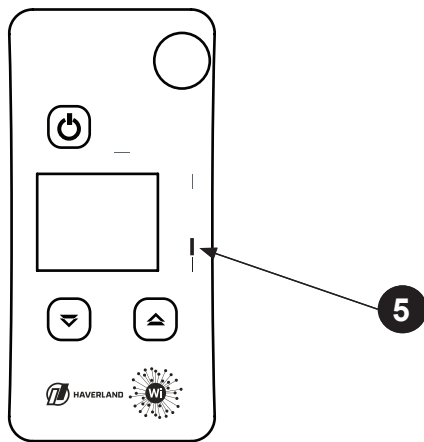

4. Bateria

O emissor está equipado com uma bateria de lítio de longa duração.

Depois de trocar a bateria, deve acertar o dia e a hora (ver o ponto 3.7) (o ajuste da hora é automático se tem uma Smartbox).

5. Manutenção

Este emissor térmico não requer nenhum tipo de manutenção especial.

Limpe simplesmente o pó acumulado com um pano seco e macio.

É conveniente, ao iniciar a temporada de aquecimento, limpar o pó acumulado na superfície do emissor.



NUNCA UTILIZE DISSOLVENTES NEM PRODUTOS ABRASIVOS.

6. Smartbox (não incluída)

Esteja onde esteja, controle à distancia todas as funções do emissor.

Programe o seu emissor a partir da App Haverland

Controlo 3G Wifi na palma da sua mão com noutra Smartbox (não incluída).

Consulte com seu estabelecimento o envie um correio a i2control@haverland.com.



Avertissements généraux

FRANÇAIS

- Veuillez lire les instructions explicatives pour son montage.
- Pour déconnecter l'émetteur du réseau électrique, retirer la prise d'alimentation de la prise. Ne tirez jamais du câble.
- Ne pas laisser le câble de connexion en contact avec l'appareil tant qu'il est allumé.
- Pendant son fonctionnement, maintenez obligatoirement l'appareil éloigné de matériaux combustibles tels que des rideaux, moquettes, meubles, etc.
- **NE PAS COUVRIR L'APPAREIL. NE L'UTILISER PAS POUR SÉCHER DES VÊ**



S'il se couvre, il existe le risque de produire une surcharge.

-  **DANGER** : Si le câble d'alimentation est endommagé, il doit être remplacé par le fabricant ou par son service après-vente, par un personnel qualifié similaire afin d'éviter un danger.
- Si l'appareil va être installé dans une salle de bain, il doit être placé de telle sorte que l'appareil ne puisse pas être touché par n'importe quelle personne qui se trouve dans la baignoire ou la douche.
- L'appareil ne doit pas être situé sous ou devant une prise de courant.
- Au moment de se débarrasser des émetteurs, on doit tenir en compte des conditions requises établies par la législation pour le traitement et recyclage des déchets.
- L'installation doit être effectuée selon la législation électrique en vigueur.
- Cet appareil doit être connecté à une prise de terre.
- L'émetteur doit être installé de telle sorte que la prise d'alimentation soit toujours accessible.
- Cet émetteur ne doit pas être encastré. Respecter toujours les distances de sécurité.
- Pour éviter que les enfants ne puissent varier la programmation de l'émetteur, celui-ci dispose d'un blocage.
- Cet appareil n'a pas été fabriqué pour être utilisé par des personnes (y compris des enfants) avec des capacités physiques réduites, sensorielles ou mentales, avec peu d'expérience ou connaissance, à moins qu'elles ne soient sous la supervision d'une personne responsable de leur sécurité avec les instructions d'usage de l'appareil. Les enfants doivent être supervisés pour s'assurer qu'ils ne jouent pas avec l'appareil.
- Les enfants âgés de moins de 3 ans doivent se

maintenir hors de la portée de l'appareil à moins qu'ils ne soient continuellement supervisés.

- Les enfants âgés entre 3 ans et 8 ans doivent allumer / éteindre l'appareil uniquement si celui-ci a été placé ou installé dans sa position de fonctionnement normal prévue et s'ils sont supervisés ou ont reçu des instructions relatives à l'usage de l'appareil d'une façon sûre et s'ils comprennent les risques de l'appareil.
- Les enfants âgés entre 3 ans et 8 ans ne doivent ni brancher l'appareil, ni le régler, ni le nettoyer et ni réaliser des opérations d'entretien.
- Cet appareil peut être utilisé par des enfants âgés de plus de 8 ans et par des personnes avec handicaps physiques, sensorielles ou mentales, ou sans expérience ni connaissances, à condition qu'ils aient été dûment formés et s'ils sont supervisés par une personne qui comprend les risques.

Le nettoyage et l'entretien à réaliser par l'utilisateur ne doivent pas être faits par des enfants. Les enfants ne doivent pas jouer avec l'appareil.



- **PRÉCAUTION** : Certaines parties de ce produit peuvent devenir très chaudes et causer des brûlures. On doit accorder une attention particulière quand les enfants et les personnes vulnérables seront présents.



- **PRÉCAUTION** : Maintenir à l'écart les sacs et autres accessoires hors de la portée des enfants.

- Évitez de toucher les parties externes de l'émetteur pendant son fonctionnement.
- Il est normal que lors du premier démarrage l'appareil détache une odeur "à neuf". Faites fonctionner votre émetteur dans un lieu ventilé pendant 2 ou 3 heures.
- Avant chaque campagne d'hiver ou si l'appareil a été débranché pendant plusieurs jours, nettoyez l'appareil avant de le connecter (suivez les pas "section Entretien"). Avec ce nettoyage, vous éviterez "de brûler la poussière accumulée et d'autres restes.
- Cet émetteur peut fonctionner avec des standards externes programmables ou tout autre dispositif de contrôle extérieur.
- L'effet de la convection, conjointement avec d'autres facteurs de l'environnement, peut provoquer une décoloration des surfaces métalliques et plastiques.
- Les contrastes de température peuvent générer "des craquements" ou des bruits dans l'appareil. Ce n'est pas une défaillance du radiateur.
- La garantie de l'appareil ne couvrira pas tout dommage causé par la non lecture de ces instructions.

1 Introduction

1.1 Description

Les Wi sont une nouvelle gamme d'émetteurs thermiques qui incorporent le thermostat intelligent i2Control.

1.2 Caractéristiques

- Thermostat i2Control auto programmable. Il n'est pas nécessaire que vous programmez son émetteur. **L'appareil s'autoprogramme tout seul.**
- Grâce à son capteur de présence et ses algorithmes, il fait un monitoring en continu vos coutumes de vie en contrôlant à tout moment sa consommation électrique, et surtout son confort.
- Il présente trois modes de fonctionnement : mode "apprentissage", mode capteur et mode manuel.
- Détection de fenêtres ouvertes. Si vous laissez la fenêtre ouverte, l'appareil se déconnecte éviter un gaspillage d'énergie.
- Le clavier est tactile et sensible.

1.3 Panneau de commandes / Écran

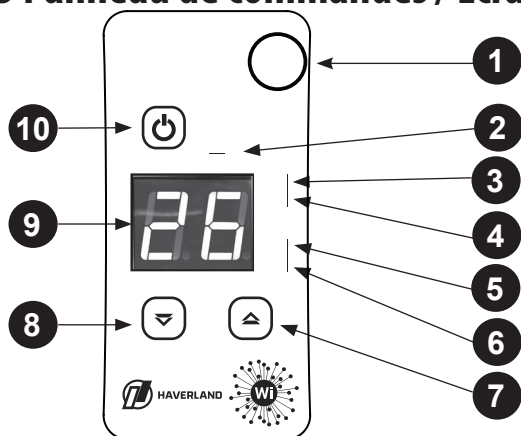

Description :

1. Capteur
2. Indicateur de température
 - Rouge = Confort
 - Bleu = Antigel
 - Vert = Économie
3. Indicateur Mode de Fonctionnement :
 - Clignotement = Mode "Apprentissage"
 - Fixe = Mode Capteur
 - Éteint = Mode Manuel ou mode programmation forcé (via App avec Smartbox non intégré)
4. Indicateur Mode programmation forcé (via App avec Smartbox non intégré)
5. Indicateur de Capteur
6. Chauffage allumé
7. Augmenter

8. Diminuer
9. Écran :
 - Température ambiante
 - Température sélectionnée
 - Horloge et jour
10. Standby

2 Installation

2.1 Normes:

- Il est indispensable que l'émetteur se fixe **FERMEMENT À UN MUR FERME ET NIVELÉ.**
- **Pour optimiser la détection de présence de votre émetteur, évitez de l'installer dans un angle "mort" ou derrière un meuble.**
- L'émetteur ne doit jamais être placé juste au-dessous d'une prise de courant.

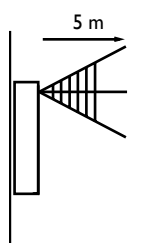
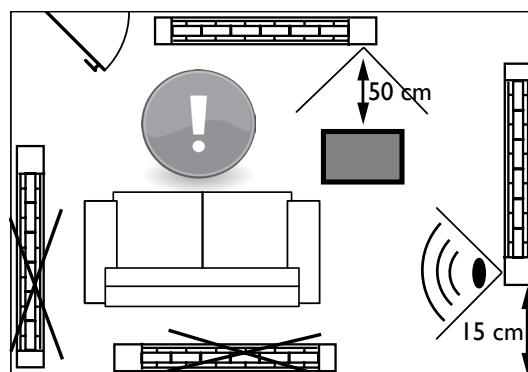

- Tenez compte du lieu d'emplacement de l'émetteur, de telle sorte qu'il puisse détecter la plus grande zone possible de la pièce.
- Le capteur de présence ne détecte pas de mouvement si la distance à l'émetteur est supérieure à 5 m.
- Tenez compte du capteur car il détecte des mouvements de mascottes.
- **NE PLACEZ PAS D'OBJETS DEVANT NI PRÈS DU CAPTEUR.**

2.2 Mesures de sécurité :

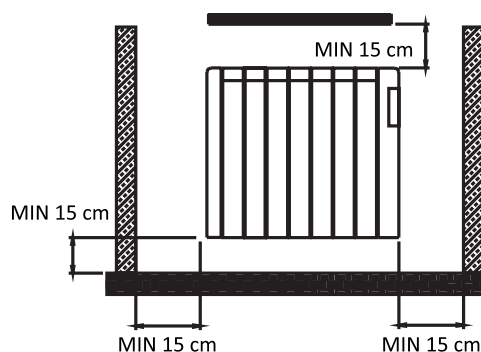

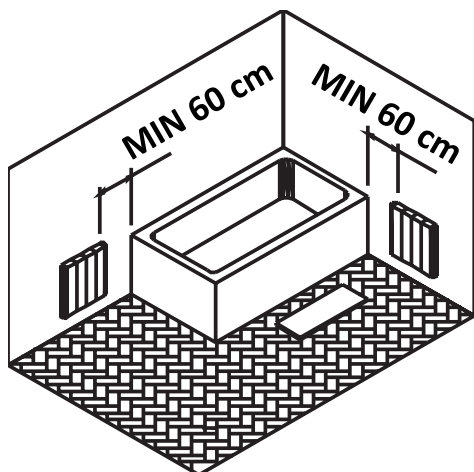

2.3 Pas à suivre :

- 1) L'émetteur doit être fixé obligatoirement FERMEMENT À UN MUR FERME ET NIVELÉ.
- 2) Retirez de l'intérieur de l'emballage le patron qui indique la position des perforations.
- 3) Vérifier qu'il existe une prise de courant à proximité où vous allez le situer.

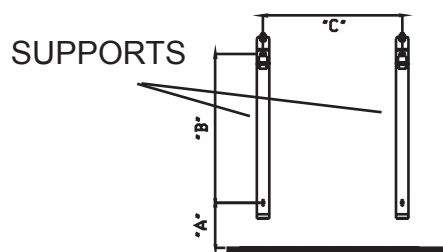
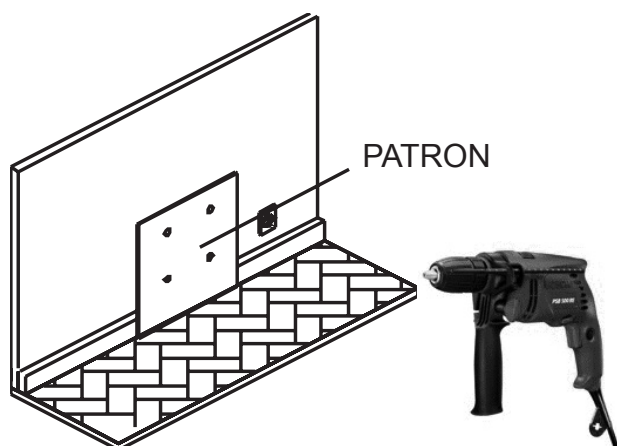

- 4) Dans les 4 perforations réalisées, introduire les 4 taquets de diamètre 8 mm et fixer les 2 supports au mur avec les 4 vis 5,5 x 50 mm.

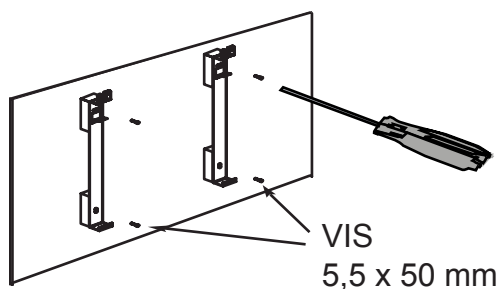

- 5) Visser dans chaque support, les 2 vis de M. 6 x 40.

2 VIS
M. 6 x 40 mm

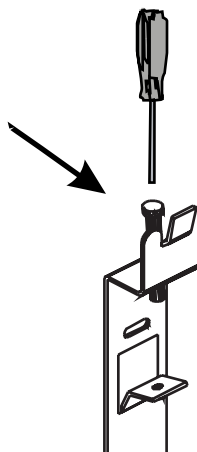

- 6) Positionnez l'émetteur dans la partie inférieure des supports.

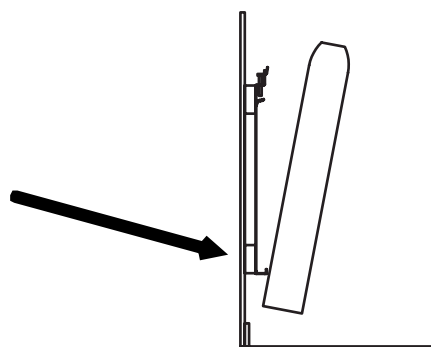

- 7) Fixer l'émetteur dans la partie supérieure des supports:

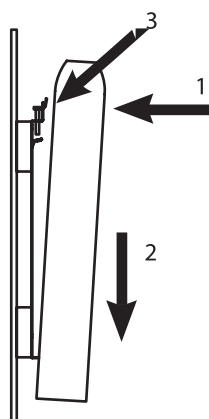

1 Positionnez et fixez l'émetteur dans la partie supérieure des supports sur les pattes prévues pour cela.

Pressionnez vers le bas pour l'adapter.

- 8) Vissez à fond les 2 vis M. 6 x 40 mm pour fixer l'émetteur au mur.

3 Fonctionnement

3.1 Votre émetteur est configuré!

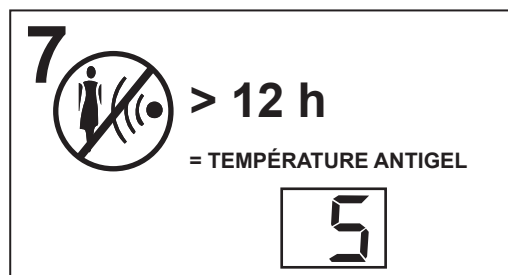
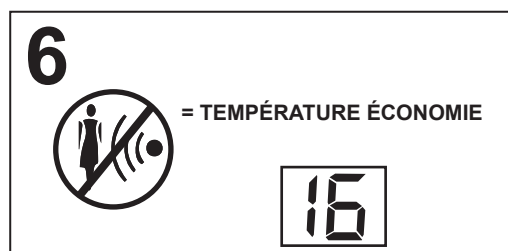
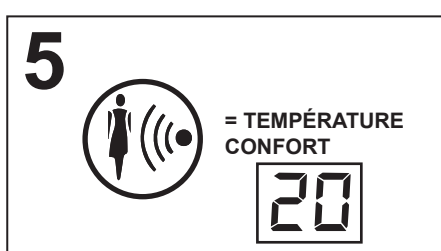
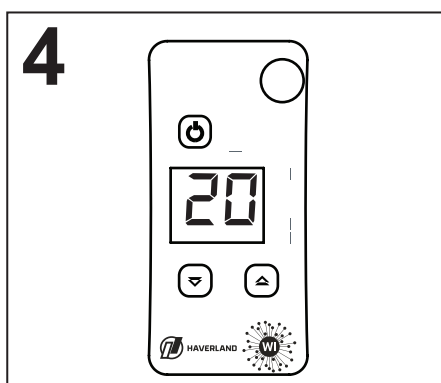
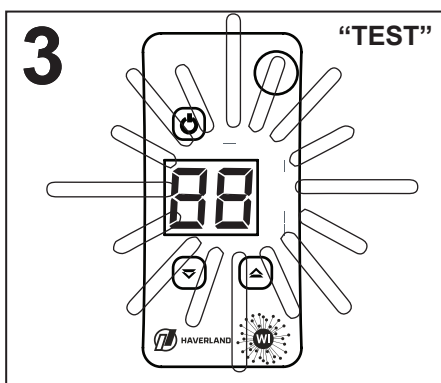
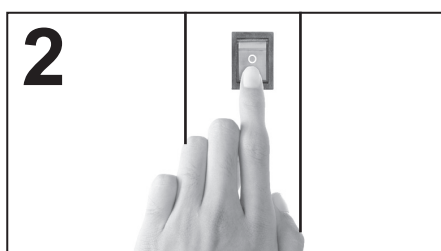
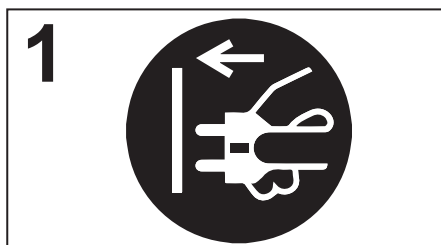

* Votre émetteur est prêt pour apprendre vos habitudes de vie et pour chauffer SANS BESOIN DE PROGRAMMER QUOI QUE CE SOIT.

* Selon notre présence, il déterminera un patron pour chaque jour de la semaine ainsi que semaine après semaine.

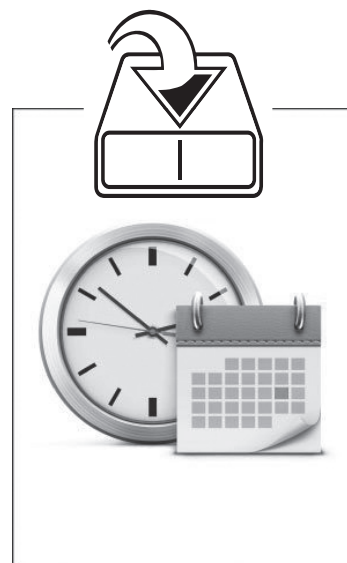

* L'émetteur n'arrête JAMAIS d'apprendre. Si nous changeons nos habitudes de nous lever, de nous coucher, etc., l'appareil se reprogramme pour s'adapter aux nouvelles habitudes.

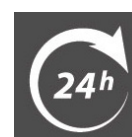



N.B. : Paramètres de série :

- 1) Horloge et jour actuel programmés de série.
- 2) Température de confort = 20 °C.
- 3) Température d'économie = 16 °C
- 4) Mode de fonctionnement activé = Mode "apprentissage".
- 5) Profil de fonctionnement activé en mode "apprentissage" = Profil Economique "PE".

3.2 Modes de fonctionnement

Votre émetteur dispose de 4 modes de fonctionnement. D'usine, le mode "apprentissage" est activé. Pour changer le mode de fonctionnement :

Appuyez à la fois sur les touches  et  chaque fois que vous souhaitez changer de mode de fonctionnement.

L'indicateur lumineux 3 changera :

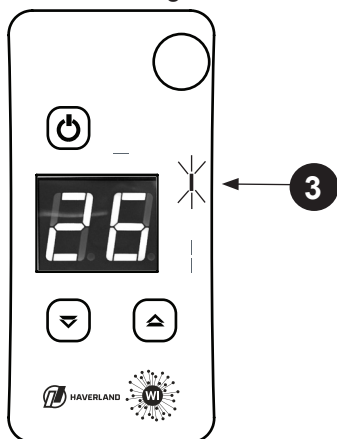

- 1) Mode "Apprentissage": Lumière "clignotement lent".
- 2) Mode Manuel : Lumière OFF.
- 3) Mode Capteur : Lumière fixe.
- 4) Mode programmation forcé (via App avec Smartbox non intégré).



1) MODE APPRENTISSAGE (activé d'usine) :

Pendant 7 jours, et de FAÇON CONTINUE, semaine après semaine, votre émetteur apprendra votre style de vie.

L'émetteur Wi dispose de 2 profils de fonctionnement:

* Profil Economique "PE" (Activation de l'usine):



Ce profil permet principalement d'économiser de l'énergie

- 1) S'il y a détection :  **Mode Confort.**
- 2) S'il n'y a PAS de détection :  > 30 minutes = Mode Économie.
- 3) S'il n'y a PAS de détection :  > 12 heures = Mode Antigel

* Profil Confort "PC":

Ce profil apporte principalement le confort et le bien être.

Ce profil permet principalement d'économiser de l'énergie

- 1) S'il y a détection :  **Mode Confort.**
- 2) S'il n'y a PAS de détection :  > 30 minutes = Mode Économie.
- 3) S'il n'y a PAS de détection :  > 16 heures = Mode Antigel



Jour après jour, l'Wi "apprend" les périodes de présence (confort) et les périodes d'absence (économie).

Après 7 jours, l'appareil débutera son fonctionnement suivant les périodes de présence (confort) et d'absence (économie) programmées, selon le profil de travail choisi.

À la semaine suivante, les périodes de confort commenceront avant l'heure programmée, pour que vous ayez du chauffage avant que vous n'entriez dans la pièce.

N.B. : La période d'auto-programmation est continue. Wi actualise conformément vos variations de style de vie, jour après jour, semaine après semaine.

2) MODE CAPTEUR :

- S'il y a détection :  = Mode Confort
- S'il n'y a PAS de détection > 30 minutes  = **Mode d'économie.**
- S'il n'y a PAS de détection > 12 heures  = Mode Antigel



Le thermostat ne mémorise RIEN.

3) MODE MANUEL:

De cette manière, vous choisissez quand vous souhaitez obtenir la température Confort, la température Économie ou la température Antigel.

Une fois choisi ce mode Manuel, il suffit de choisir Confort, Antigel ou Économie et la température ambiante souhaitée.

3.3 Ajustement de la température

Pour changer les températures de confort et d'économie, l'émetteur doit être en MODE MANUEL (VOIR POINT 3.2).

L'appareil de série, les températures programmées sont :

1) TEMPÉRATURE CONFORT = 20 °C

2) TEMPÉRATURE ÉCONOMIE = 16 °C

3) TEMPÉRATURE ANTIGEL = 5 °C



La température antigel (5 °C) est invariable.

3.4 Températures de Confort, Antigél et Économie

Le thermostat a 3 températures de pré-ajustage de température.

La température en fonctionnement est précisée avec des couleurs dans l'indicateur lumineux 2 :

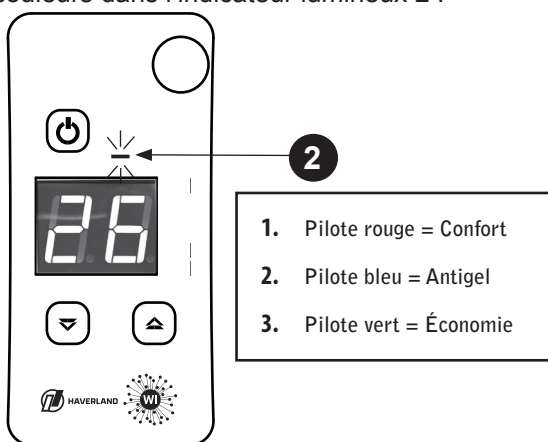

L'ajustement par défaut de la température de confort (quand l'occupant est dans la chambre) est de 20°C.

L'ajustement par défaut de la température d'économie (quand l'occupant est absent de la chambre ou en train de dormir) est de 16 °C.

L'ajustement par défaut de la température d'antigel (quand l'occupant est absent plus de 12 heures de la chambre) est de 5 °C.

Pour modifier la température de confort ou d'économie (la température antigel est fixe) :

1. Pour changer les températures de confort et d'économie, l'émetteur doit être en **MODE MANUEL** (VOIR POINT 3.2).

2. Choisissez la température à changer, confort, antigél ou économie, en appuyant sur la touche

1. Pilote rouge = Confort
2. Pilote bleu = Antigél
3. Pilote vert = Économie

3. Appuyez sur la touche . Clignotera la température ajustée pendant quelques secondes.

4. Appuyez sur n'importe quel bouton et plus d'une fois pour changer la température ajustée.



N.B. :

• Le rang de la température de confort est de 18 à 28 °C.

• La valeur maximale de la température d'économie est de 18 °C.

• La température d'économie ne peut JAMAIS être supérieure à la température de confort.

• La température d'économie peut être entre 4 °C et 8° C inférieure à la température de confort assignée. (Rappel : La valeur maximale de la température en économie est de 18 °C).

3.5 Fonction "Fenêtres Ouvertes"

L'émetteur dispose de cette fonction **automatique**, **disponible seulement en mode capteur (voir 3.2)**.

Si dans la pièce où se trouve situé l'émetteur, se produit une forte chute de température ambiante, l'émetteur passera au mode "antigel" (5°C).

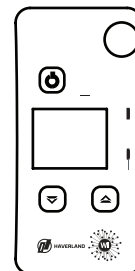
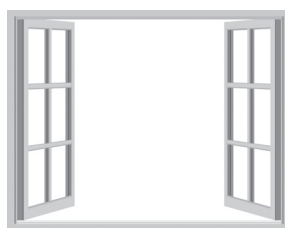

L'appareil recommencera à fonctionner automatiquement quand quelqu'un entrera dans la pièce.



Cette fonction ne peut pas être désactivée.

3.6 Fonction "Blocage du clavier"

Pour bloquer et pour débloquer le clavier, appuyez à la fois sur les touches et .

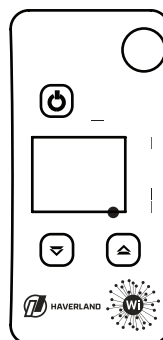

N. B. :

L'écran tout comme les indicateurs lumineux s'éteignent. Apparaît une lumière à droite de l'écran.

3.7 Standby

Pour allumer et éteindre l'émetteur appuyez .

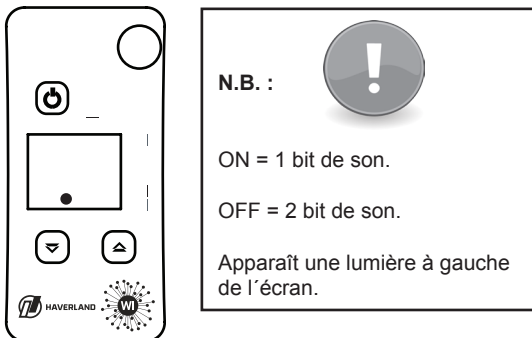

3.8 Ajustement du Jour et de l'Heure

Votre émetteur vient ajusté d'usine avec l'horloge et le jour de la semaine.

Dans les changements d'horaires d'été et d'hiver, vous devrez ajuster l'horloge de l'appareil (cet ajustement est automatique s'il comprend le Smartbox).



1. Appuyez sur le bouton  et sur le bouton . Le symbole "d" apparaîtra à l'écran.



Patientez.

A continuation, un numéro de 1 à 7 clignote en indiquant le jour de la semaine.



Patientez. Ajustez le jour de la semaine en appuyant sur  ou . Patientez.

2. Le symbole "h" apparaît.



Patientez.

A continuation, la valeur affichée pour les heures clignotent.



Ajustez l'heure  ou . Patientez.

3. A continuation, le symbole "n" apparaît à l'écran.



Patientez.

A continuation, la valeur affichée pour les minutes clignote.



Ajustez les minutes  ou .

Patientez.

4. A continuation, apparaît le profil de fonctionnement en mode apprentissage "PE", "Profil Economique".

Le profil PE "Economique" permet d'économiser de l'énergie alors que le profil "PC", "Profil Confort" apporte le bien être.



Ajustez le profil  ou .

Pour finaliser, apparaît la température approximative de la pièce.

3.9 Autres indications

3.9.1 Indicateur Résistance Allumée:

Quand l'émetteur est en train de chauffer, l'indicateur lumineux 6 restera allumé.

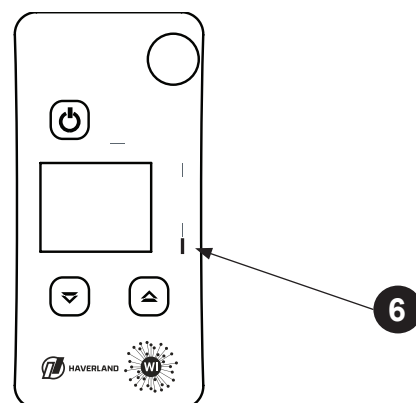

3.9.2 Indicateur Capteur connecté :

Quand le capteur est en train de détecter, l'indicateur lumineux 5 restera allumé.

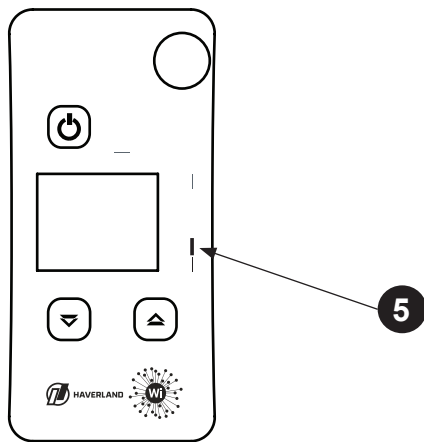

4. Batterie

Votre émetteur est équipé d'une batterie de lithium de longue durée.

Après avoir changé la batterie, vous devrez ajuster le jour et l'heure (voir point 3.7) (cet ajustement est automatique s'il comprend le Smartbox).

5. Entretien

Votre émetteur thermique ne requiert aucun type d'entretien spécial.

Nettoyez seulement la poussière qui pourrait s'accumuler avec un chiffon sec et doux.

Il convient au commencement de la saison de chauffage, enlever la poussière accumulée sur la surface de l'émetteur.



**N'UTILISEZ JAMAIS DES DISSOLVANTS
NI DES PRODUITS ABRASIFS.**

6. Smartbox (non fourni)

Contrôlez à distance toutes les fonctions de votre émetteur depuis n'importe quel endroit.

Programmer votre émetteur depuis l'App Haverland.

Contrôle 3G Wifi sur la paume de votre main.
Confort et économie en temps réel.

Consultez auprès de votre distributeur ou à travers de i2control@haverland.com



General Warnings

- Please read the explanatory instructions covering installation.
- To disconnect mains power from the heater remove the plug from the wall socket, but never pull on the cable.
- Do not leave the mains cable in contact with the heater when it is switched on.
- During operation, the heater must be kept well away from combustible materials, such as curtains, carpets and furniture etc.
- **DO NOT COVER THE HEATER. DO NOT USE IT TO DRY CLOTHES.**



If it is covered, there is a risk over overheating.



- **DANGER:** If the mains power cable is damaged, it must be replaced by the manufacturer, its after-sales service or similarly qualified persons, in order to prevent any danger.
- If the heater is to be installed in a bathroom, it must be positioned so that it cannot be touched by anybody in the bath or shower.
- The unit must not be installed below or in front of a mains socket.
- When the heater is disposed of, the requirements established by current legislation on waste processing and recycling shall be taken into account.
- The installation shall be carried out according to current electrical legislation.
- This unit shall be connected to earth.
- The heater shall be installed so that its mains plug is always accessible.
- This heater cannot be flush-mounted with a wall. Safety distances shall always be respected.
- The heater is fitted with a block so that children cannot change the programming.
- This unit is not designed to be handled by persons (including children) with physical, sensorial or mental handicaps, with little experience or knowledge unless they are under the supervision of an adult responsible for their safety with the instructions on its use. Children shall always be supervised to ensure they do not play with the unit.
- Children under three shall be kept well away from the heater unless they are continually supervised.
- Children between three and eight shall only switch the unit off or on providing it is positioned or installed in its final operating location and be

ENGLISH

supervised or have received instructions on how to use the unit in a safe manner and understand the risks involved.

- Children between three and eight shall not plug in, adjust or clean the heater or carry out any maintenance operations.
- This unit may be used by children older than eight and by persons with physical, sensorial or mental handicaps, with little experience or knowledge, provided they have been duly trained and are supervised by an adult that understands the risks involved.

Cleaning and maintenance shall be performed by adults not children. Children must not play with the unit.



- **PRECAUTION:** Certain parts of this product can become very hot and cause burns. Special attention shall be paid when children and other vulnerable persons are present.



- **PRECAUTION:** Keep bags and other accessories well away from children.

- Do not touch the external parts of the heater when it is operating.
- It is quite normal that, with the first switch-on, the unit produces a “new” smell. Allow your heater to operate in a well-ventilated place for two or three hours.
- Before the first switch on for the coming winter or when the heater has not been used for several days, the unit should be cleaned (follow the steps given in the “maintenance section”). This cleaning operation will avoid burning the accumulated dust and other remains.
- This heater can operated with external programmable controllers or any other exterior control device.
- The convection effect, together with other ambient factors, can cause discolouring to metal surfaces and to plastics.
- Temperature differences can cause crackling and other noises in the unit. This does not indicate any failure in the heater.
- The warranty for the heater does not cover any damage cause by not reading these instructions.

1 Introduction

1.1 Description

The Wi is a new range heater employing that incorporates the **smart i2Control thermostat**.

1.2 Characteristics

- i2Control auto-programmable thermostat. You do not have to programme your heater. The unit will do it for you automatically.
- Its presence sensor and algorithms continually monitor your life style habits and controls your electricity consumption at all times, especially your comfort.
- It has three operating modes, “learning”, sensor and manual.
- Open window detection. If you leave a window open, the unit will switch itself off to prevent energy wastage.
- The keyboard in touch sensitive.

1.3 Panel controls / Screen

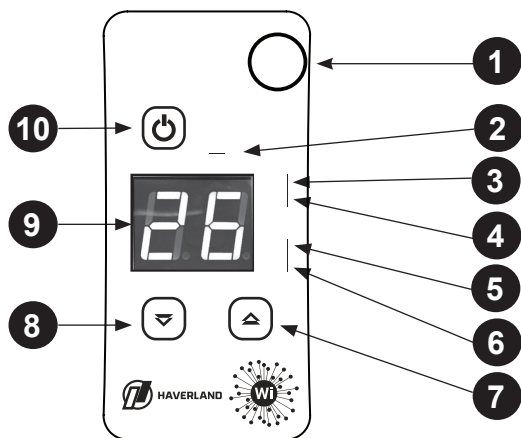

Description :

1. Sensor
2. Temperature indicator
 - Red = Comfort
 - Blue = Anti-frost
 - Green = Economy
3. Operating mode indicator:
 - Flashing = “Learning” mode
 - Fixed = Sensor mode
 - Off = Manual mode or “Forced” programming mode (via Smartbox App (not included)).
4. “Forced” programming mode (via Smartbox App (not included)).
5. Sensor indicator
6. Heating On
7. Increase
8. Decrease

9. Screen:

- Ambient temperature
- Selected temperature
- Clock and day

9. Standby

2 Installation

2.1 Regulations:

- It is essential that the heater IS FIRMLY FIXED TO A FIRM WALL AND LEVELLED.
- In order to optimize presence detection of your heater, do not install it in a “dead” angle or behind a piece of furniture.
- The heater must never be installed just below a mains socket.

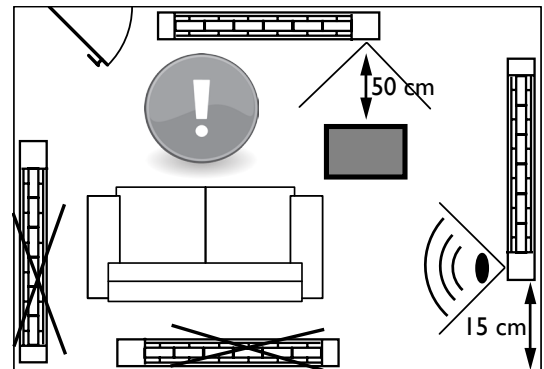

- Take into account the heater location so that it can detect presence over the largest possible area of the room.
- The presence sensor will not detect any movement if the distance to the heater exceeds five metres.
- Remember that the sensor will detect the movement of pets.
- **DO NOT PLACE ANY OBJECTS IN FRONT OF OR ANYWHERE NEAR THE SENSOR.**

2.2 Safety measures:

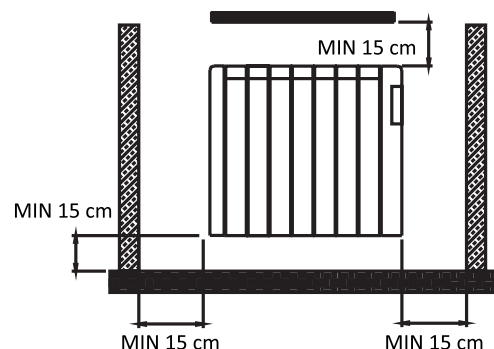

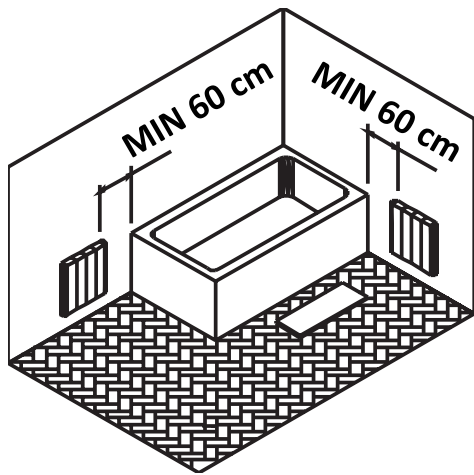

2.3 Steps :

- 1) It is essential that the heater IS FIRMLY FIXED TO A FIRM WALL AND LEVELLED.
- 2) Remove the template indicating the drill holes from the packing case.
- 3) Check if there is a mains socket near the heater location.

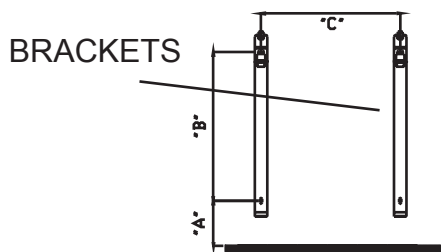
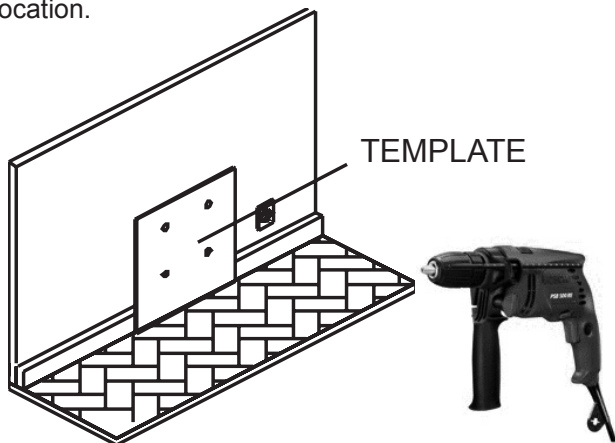

- 4) Insert the four 8-mm diameter wall plugs into the four drill holes and fix the two brackets to the wall with the four 5.5 x 50 mm screws.

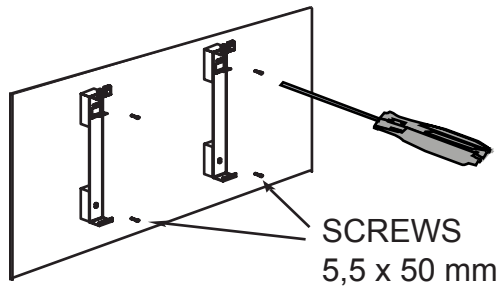

- 5) Screw the two M6 x 40 screws into each bracket.

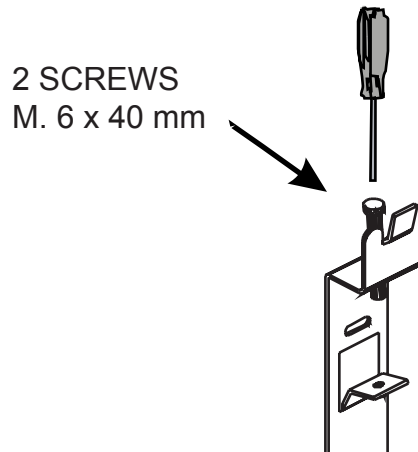

- 6) Position the heater on the lower part of the brackets.

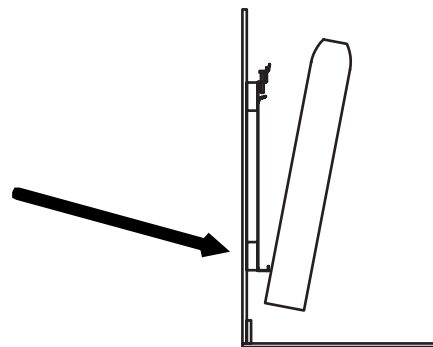

- 7) Secure the heater to the upper parts of the brackets:

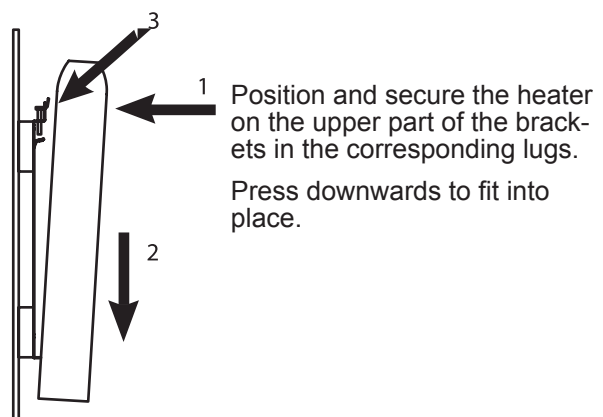

- 8) Fully screw in the two M6 x 40 mm screws to fix the heater to the wall.

3 Operation

3.1 Your heater is configured!

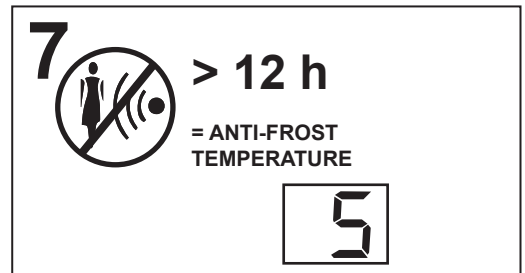
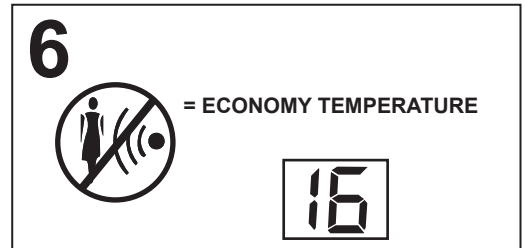
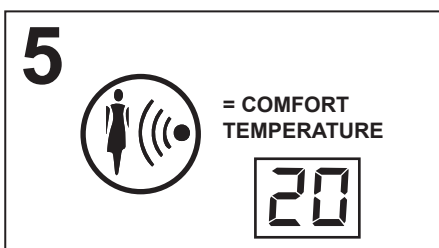
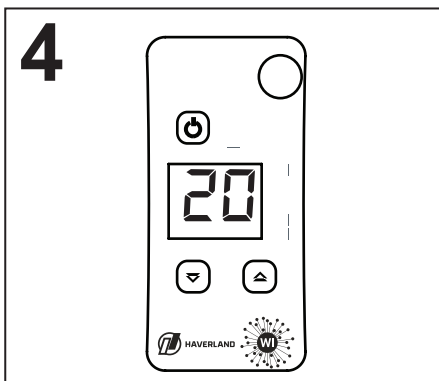
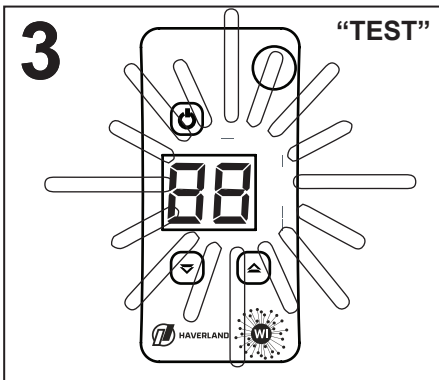
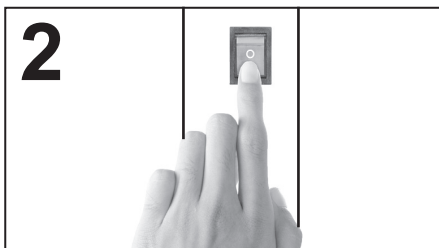
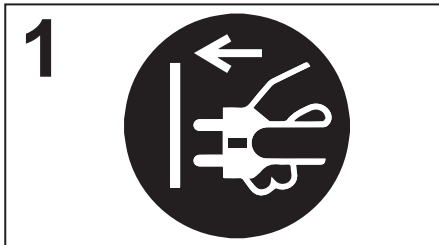

* Your heater is now ready to learn your life style habits and to provide heat WITHOUT ANY NEED TO PROGRAMME ANYTHING.

* According to your presence, it will learn a template for each day of the week, week by week.

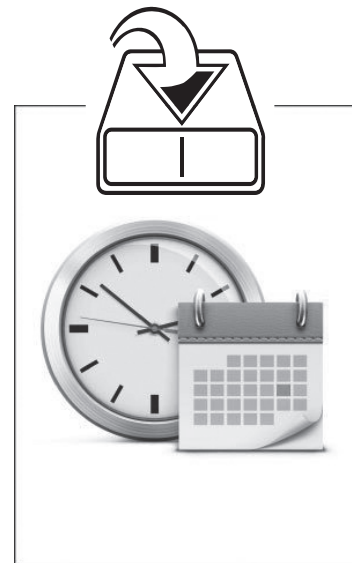

* The heater **NEVER** stops learning. If you change your habits of getting up and going to bed etc, the unit will re-programme itself to adapt to your new habits.

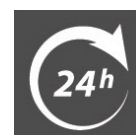

NOTE: Factory-set parameters:

- 1) Cloak and current day are factory set.
- 2) Comfort temperature = 20 °C.
- 3) Economy temperature = 16 °C
- 4) Activated operating mode = "Learning" mode.
- 5) Activated working profile in "Learning" Mode = Economic Profile "PE"

3.2 Operating modes

Your heater incorporates four operating modes. The "learning" mode is activated at the factory. To change the operating mode:

Simultaneously press  and  every time you want to change the operating mode.

Light indicator 3 will change:

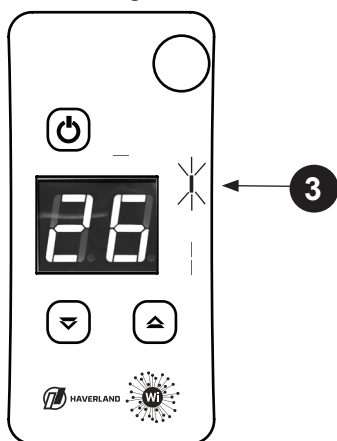

- 1) "Learning" mode: "slowly flashing" light.
- 2) Manual mode: light is OFF.
- 3) Sensor mode: fixed light.
- 4) "Forced" programming mode (via Smartbox App (not included)).



1) LEARNING MODE (factory activated):

During seven days and CONTINUALLY, week by week, your heater will be learning your life style.

The Wi emitter has 2 working profiles:



* Economic Profile "PE" (Default factory settings)

This profile prioritizes the energy savings.

- 1) If there is detection:  **Comfort mode.**
- 2) If there is no detection:  > 30 minutes = **Economy mode.**
- 3) If there is no detection:  > 12 hours = **Anti-frost mode.**

* Comfort profile "PC":

This profile prioritizes comfort and welfare.

- 1) If there is detection:  **Comfort mode.**
- 2) If there is no detection:  > 30 minutes = **Economy mode.**
- 3) If there is no detection:  > 16 hours = **Anti-frost mode.**



Day by day, the Smart wave is "learning" the presence (comfort) periods and the absence periods (economy).

After 7 days, the radiator will start working according to the programmed presence periods (comfort) and the absent periods (economy), depending on the chosen working profile.

The comfort periods in the following week will commence before the programmed time so that the room will be warming up before you enter.

Note: The auto-programming period is continuous. The Wi updates according to your life style variations, day by day, week by week.

2) SENSOR MODE :

- 1) If there is detection:  **Comfort mode.**
- 2) If there is no detection:  > 30 minutes = **Economy mode.**
- 3) If there is no detection:  > 12 hours = **Anti-frost mode.**



The thermostat does NOT hold anything in memory.

3) MANUAL MODE :

In this mode, you decide when you want Comfort temperature, Economy temperature or Anti-frost temperature.

When Manual mode is selected, you only have to choose Comfort, Anti-frost or Economy and the desired ambient temperature.

3.3 Adjusting the temperature

In order to change the Comfort and Economy temperatures the heater must be in MANUAL mode (see point 3.2).

The factory-set temperatures are:

- 1) COMFORT TEMPERATURE = 20 °C
- 2) ECONOMY TEMPERATURE = 16 °C
- 3) ANTI-FROST TEMPERATURE = 5 °C



The anti-frost temperature (5 °C) cannot be changed.

3.4 Comfort, Anti- frost and Economy Temperatures

The thermostat has three pre-adjusted temperatures.

The operating temperature is shown in colours light indicator 2:

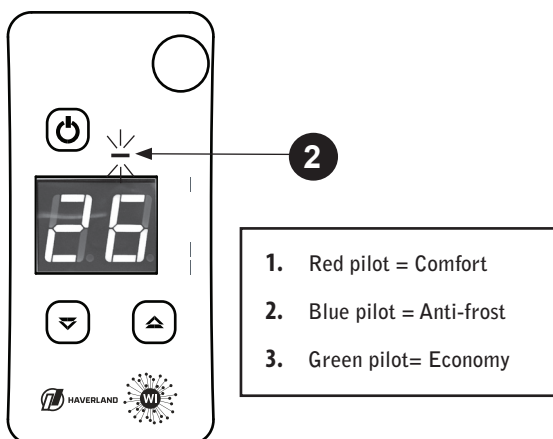

The default comfort temperature adjustment (when the room is occupied) is 20 °C.

The default economy temperature adjustment (when the room is not occupied or someone is sleeping) is 16 °C.

The default anti-frost temperature adjustment (when the occupant is absent from the room for more than twelve hours) is 5 °C.

Comfort and economy temperatures may be modified (the anti-frost temperature is fixed):

1. To change the comfort and economy temperatures, the heater must be in **MANUAL MODE** (see point 3.2).

2. Select the temperature to be changed, comfort, anti-freezing or economy, pressing key .

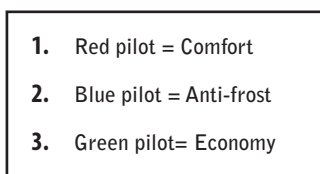

3. Press key . the adjusted temperature will appear flashing for several seconds.

4. Press either of buttons  and  more than once to change the adjusted temperature.

NOTES :

- The comfort temperature range is from 18 to 28 °C.
- The maximum economy temperature is 18 °C.
- The economy temperature can NEVER be higher than the comfort temperature.
- The economy temperature is always 4 °C less than the assigned comfort temperature.

3.5 “Open Window” Function

The heater incorporates this automatic function.

If, in the room in which the heater is installed, **the ambient temperature falls by more than 4 °C**, the heater will change over to “Anti-frost” mode”.

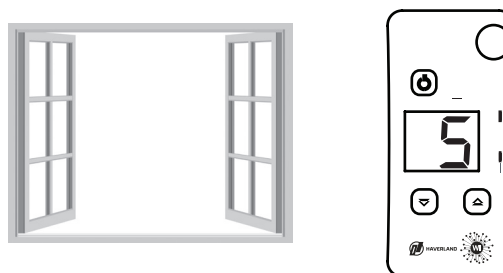



This will prevent heater operation.

The unit will automatically commence operation when somebody enters the room.

 This function cannot be deactivated.

3.6 “Keypad Block” Function

The keypad may be blocked and unblocked by simultaneously pressing keys  and .

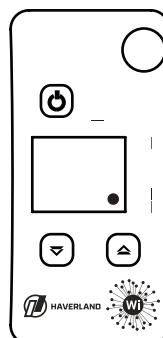

 NOTES :
<p>The screen and the pilot lights go out.</p> <p>A light spot appears on the right side of the screen .</p>

3.7 Standby

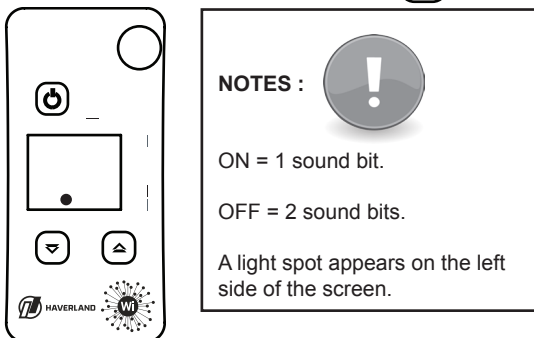

To switch the heater on and off press  .



3.8 Adjusting Day and Time

Your heater is supplied with the clock and day of the week already factory set.

You must adjust the clock for changes between summer and winter times (this is an automatic setting if you have the Smartbox (not included)).



1. Press button  and  button. A “d” will appear on the screen.



Wait.

Then a number from 1 to 7 will appear flashing to indicate the day of the week.



Wait. Adjust the day of the week by pressing  or  . Wait.



2. “h” is displayed.



Wait.

Then, the value indicating the hours will flash.



Adjust the hours using  and  . Wait.



3. Then, “n” appears on the screen.

Wait.



Then, the value indicating the minutes will flash:





Adjust the minutes using  or  .

Wait.

4. Straight away, the working profile will appear and show the learning mode “PE”, “Economy Profile”.

On the “Economy” PE, the energy savings is prioritized, while on the Comfort Profile “PC” it prioritizes your comfort.



To set up the profile using  or  .

Wait.

Then, to finalise, the approximate room temperature appears.

3.9 Other Indications

3.9.1 Heating Element ON Indicator:

When the heater is operating, pilot lamp 6 will be on.

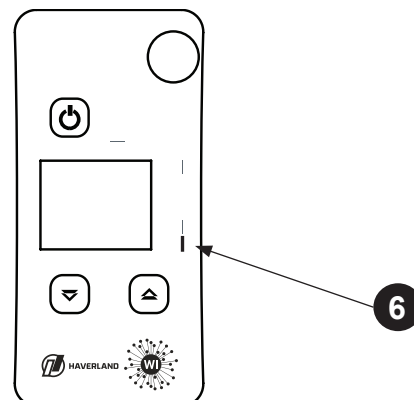

3.9.2 Sensor Indicator On:

When the sensor is detecting, pilot lamp 5 will be On.

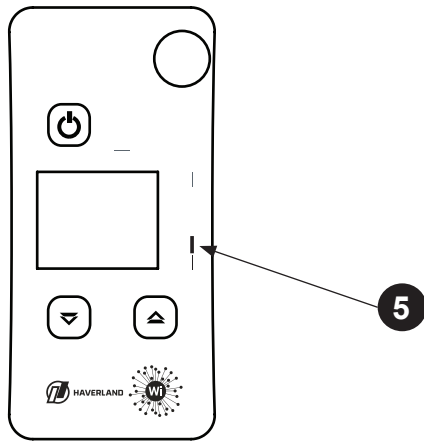

4. Battery

Your heater is fitted with long-duration lithium battery.

When the battery is replaced, the day of the week and the time have to be re-adjusted (see point 3.7) (this is an automatic setting if you have the Smartbox (not included)).

5. Maintenance

Your heater does not require any special maintenance.

It is only necessary to remove any accumulated dust with a soft dry cloth.

It is recommended that when the unit is brought out for the winter months, all accumulated dust on its surfaces should be removed.



NEVER USE SOLVENTS OR ABRASIVE PRODUCTS.

6. Smartbox (not supplied)

Wherever you are, you can remotely control your radiator.

Program your radiator using Haverland's App.

3G Wifi control in the palm of your hand Comfort and savings (monitoring).

Contact your distributor or write to i2control@haverland.com

GUARANTEE

1. Haverland guarantees against material, design or manufacturing faults at the moment of its original acquisition and it also guarantees for 2 years, the electronic components and paintwork/finish for 3 years and lifetime for the aluminium body (exclude accidental damage, transport, and misuse).
2. If, during the guarantee period, the product were to become faulty and this is due to a design fault or a fault in the material or the manufacturing, Haverland will repair or replace the product, whichever it deems appropriate, under the conditions stipulated below:
 - 2.1. The guarantee is only valid if the original Guarantee Certificate issued by the distributor or installer to the purchaser is presented and when the aforementioned guarantee stipulates the series N° and model of the product (shown on the technical characteristics sticker) and date of purchase. HAVERLAND reserves the right to refuse the guarantee service if this information has been removed or modified after the original purchase of the product. The receipt or original invoice will only be accepted as a proof of purchase when presented to the distributor or installer who sold the product.
 - 2.2. The guarantee only applies to the cases relative to material, design or manufacturing faults; under no circumstances does it cover damage to the radiator due to the following:
 - 2.2.1. Incorrect use of the product for purposes that are not normal or without respecting instruction manuals as to the use and maintenance of the product, as well as the installation or use of the product in a way that does not comply with the technical safety standards in force.
 - 2.2.2. Repairs performed by unauthorised service workshops or the opening of the radiator by unauthorised persons.
 - 2.2.3. Unforeseen accidents that are out of Haverland's control, such as lightning, fires, floods, public disturbances, etc.
 - 2.2.4. The repairs or replacements covered by this guarantee do not allow the extension or new start up of the guarantee period.
 - 2.2.5. Faulty pieces or components removed, remain the property of Haverland.
 - 2.2.6. This guarantee does not affect the purchaser's legal rights set forth by the national legislation in force, or the purchaser's rights against those of the distributor or installer that could arise from the sale contract.
 - 2.2.7. In the absence of an applicable national legislation in force, this guarantee will serve to be the purchaser's only protection. Haverland, its offices and distributors and installers will not be held responsible for any kind of damages, either fortuitous or accidental derived infringing any implicit regulation related to this product.

REF.	W	Nº IIII	
Wi-3	450	3	230 V 50 HZ CLASE I CLASSE 1 CLASS 1
Wi-5	800	5	
Wi-7	1100	7	
Wi-9	1400	9	
Wi-11	1700	11	



INFORMACIÓN IMPORTANTE PARA DESECHAR CORRECTAMENTE EL PRODUCTO DE ACUERDO CON LA DIRECTIVA 2002/96/EC

Al final de su vida de servicio útil, el producto no debe ser desechado como un residuo urbano. Éste debe llevarse a un centro especial del municipio local para la recogida de residuos diferenciados o a un concesionario que proporcione este servicio.

El desecho de un aparato doméstico de modo separado evita las posibles consecuencias negativas para el medio ambiente y la salud que se derivan de un desecho inadecuado y permite la recuperación de los materiales constituyentes para obtener ahorros significativos de energía y recursos. Para recordar la necesidad de desechar el aparato doméstico de modo separado, el producto está marcado con un cubo de basura con ruedas tachado con una cruz.



INFORMAÇÃO IMPORTANTE PARA SE DESFAZER CORRECTAMENTE DO PRODUTO DE ACORDO COM A DIRECTIVA 2002/96/EC.

No fim da sua vida útil, o produto não deve ser depositado junto dos outros resíduos urbanos.

O aparelho deve ser entregue num centro especial do município local para a recolha de resíduos diferenciados ou num concessionário que disponibilize este serviço.

A recolha separada de um aparelho doméstico evita as eventuais consequências negativas para o ambiente e para a saúde que resultam da não separação, além de a recuperação dos materiais componentes permitir conseguir poupanças significativas de energia e recursos. Para recordar a necessidade de se desfazer separadamente do aparelho doméstico, este está marcado com um símbolo que representa um contentor do lixo com rodas riscado com uma cruz.



INFORMATION IMPORTANTE POUR SE DÉBARASSER CORRECTEMENT DU PRODUIT CONFORMÉMENT À LA DIRECTIVE 2002/96/EC

À la fin de sa vie de service utile, ce produit ne doit pas être jeté comme un déchet urbain.

Il doit être transporté dans un centre spécial de la municipalité locale pour le ramassage de déchets différenciés, ou chez un concessionnaire qui propose ce service.

Le rebut d'un appareil domestique de façon séparée évite les éventuelles conséquences négatives pour l'environnement et la santé qui découleraient d'un rebut inadéquat, et permet la récupération des matériaux qui le constituent pour obtenir des épargnes significatives d'énergie et des recours. Pour rappeler le besoin de se défaire de l'appareil domestique de façon séparée, le produit est marqué avec une poubelle avec roues, barrée par une croix.



IMPORTANT INFORMATION FOR CORRECTLY DISPOSING THE PRODUCT IN ACCORDANCE WITH DIRECTIVE 2002/96/EC

At the end of its useful service lifetime, the product shall not be disposed of as urban waste.

It shall be taken to special centre belonging to the local municipality, which collects differentiated waste or to a concessionary that provides this service.

The disposal of domestic apparatus in a separate manner avoids the possible negative consequences on the environment and on health that derive from inadequate disposal and also allow the recovery of the constituent materials in order to obtain significant savings in energy and resources. In order to remind people of the need to dispose of the domestic apparatus in a separate manner, it is marked with a crossed-out wheeled bin.

ESPAÑA
PORTUGAL



+ 34 91 3244060

L - V: 9 - 20 h

2 - 6 Feria: 9 - 20 h

 info@haverland.com

FRANCE **HAVERLAND FRANCE**
E-mail: info@haverland.fr
Fax: + 33 (0) 1 76 50 02 88
Web: www.haverland.fr

UK **HAVERLAND UK LIMITED**
E-mail: haverland@haverland.co.uk
Phone: 0330 3651940
Fax: 01672811944
Web: www.haverland.co.uk