

Céliane métal | Fiche Legrand



Réf 068781



Réf 068782



Réf 068783



Réf 068784



Réf 068791



Réf 068792



Réf 068793



Réf 068794



Réf 066791

+8
référence(s)
supplémentaire(s)

Voir les produits Legrand : https://www.domomat.com/42_legrand

Retrouvez tous les produits Legrand
chez Domomat !

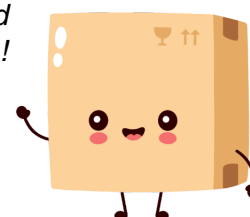

Céliane™

Plaques finition Métal

Référence(s) : 0 687 11/12/13/14/18/19/21/22/23/24/25/26/28/29
0 687 61/62/63/64/68/69/71/72/73/74/78/79/81/82/83/84/91/92/93/94
0 689 50/71/72/73/74/75/76/78/79/80
0 689 81/82/83/84/85/86/87/88/89/90/91/92/93/94/98/99

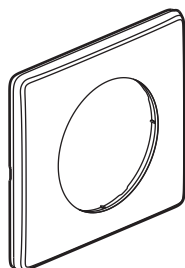

0 687 11/21/61/71/81/91 - 0 689 71/81/91

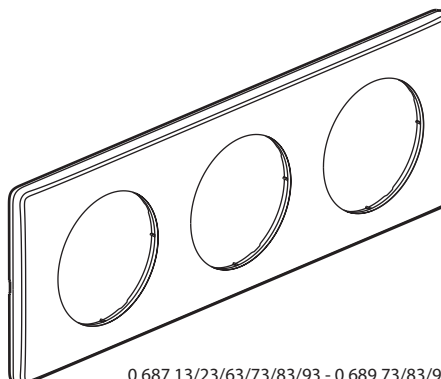

0 687 13/23/63/73/83/93 - 0 689 73/83/93

1. USAGE

Plaques permettant l'habillage de mécanismes de 1 à 6 postes.
Montage horizontal ou vertical.

2. GAMME

Plaques 1 poste

	Violet irisé	0 687 11
	Alu snake	0 687 21
	Orange snake	0 687 61
	Blue snake	0 687 71
	Nuit d'encre	0 687 81
	Laiton	0 687 91
	Tungstene	0 689 71
	Carbone	0 689 81
	Copper	0 689 91

Plaques 2 postes - Entraxe 71 mm

	Violet irisé	0 687 12
	Alu snake	0 687 22
	Orange snake	0 687 62
	Blue snake	0 687 72
	Nuit d'encre	0 687 82
	Laiton	0 687 92
	Tungstene	0 689 72
	Carbone	0 689 82
	Copper	0 689 92

Plaques 2 postes - Entraxe 57 mm

	Violet irisé	0 687 18
	Alu snake	0 687 28
	Orange snake	0 687 68
	Blue snake	0 687 78
	Tungstene	0 689 78
	Carbone	0 689 88
	Copper	0 689 98

Plaque 2 postes étendue

	Alu snake	0 687 25
	Tungstene	0 689 75
	Carbone	0 689 85

2. GAMME (suite)

Plaque 2 x 2 postes

	Carbone	0 689 50
--	---------	----------

Plaques 3 postes - Entraxe 71 mm

	Violet irisé	0 687 13
	Alu snake	0 687 23
	Orange snake	0 687 63
	Blue snake	0 687 73
	Nuit d'encre	0 687 83
	Laiton	0 687 93
	Tungstene	0 689 73
	Carbone	0 689 83
	Copper	0 689 93

Plaques 3 postes - Entraxe 57 mm

	Violet irisé	0 687 19
	Alu snake	0 687 29
	Orange snake	0 687 69
	Blue snake	0 687 79
	Tungstene	0 689 79
	Carbone	0 689 89
	Copper	0 689 99

Plaque 3 postes étendue









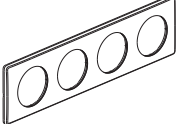

	Alu snake	0 687 26
	Tungstene	0 689 76
	Carbone	0 689 86

Plaque 3 x 3 postes



	Carbone	0 689 90
--	---------	----------

2. GAMME (suite)

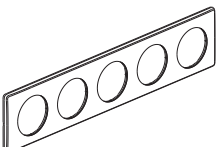

Plaque 4 postes - Entraxe 71 mm

	 Violet irisé	0 687 14
	 Alu snake	0 687 24
	 Orange snake	0 687 64
	 Blue snake	0 687 74
	 Nuit d'encre	0 687 84
	 Laiton	0 687 94
	 Tungstene	0 689 74
	 Carbone	0 689 84
	 Copper	0 689 94

Plaque 5 postes - Entraxe 71 mm

	 Carbone	0 689 80
---	---	----------

Plaque écran tactile

	 Carbone	0 689 87
---	---	----------

3. DIMENSIONS (mm)

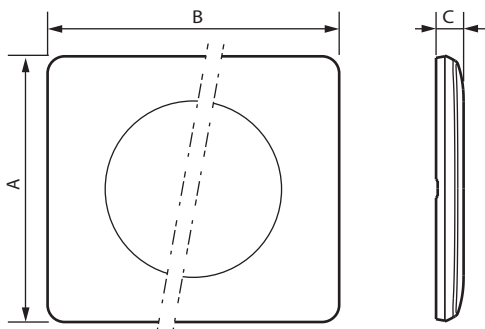

Références	A	B	C
0 687 11/21/61/71/81/91 - 0 689 71/81/91	82	90	8,5
0 687 12/22/25/62/72/82/92 - 0 689 72/75/82/85/92	82	161	8,5
0 687 13/23/26/63/73/83/93 - 0 689 73/76/83/86/93	82	232	8,5
0 687 14/24/64/74/84/94 - 0 689 74/84/94	82	303	8,5
0 687 18/28/68/78/88/98 - 0 689 78/88/98	82	147	8,5
0 687 19/29/69/79/99 - 0 689 79/89	82	204	8,5
0 689 50	159	175	8,5
0 689 90	159	246	8,5

4. CARACTÉRISTIQUES TECHNIQUES

■ 4.1 Caractéristiques matières

ABS + métal

Sans halogène

Tenue aux UV

Autoextinguibilité : 650° C / 30 s

■ 4.2 Caractéristiques climatiques

Température de stockage : - 10° C à + 70° C

5. ENTRETIEN

Nettoyage superficiel au chiffon.

Ne pas utiliser : acétone, dégoudronnant, trichloréthylène.

Tenue aux produits suivants : Hexane (EN 60669-1), Alcool à brûler, Eau savonneuse, Ammoniac dilué, Javel pure diluée à 10%, Produit à vitres, Lingettes pré-imprégnées.

Attention : Pour l'utilisation de produits d'entretien spécifiques autres, un essai préalable est nécessaire.

6. UTILISATION PARTICULIERE

Aucune peinture ne doit être appliquée sur les plaques.